

<b>Preface</b> .....	<b>1</b>
<b>Introduction</b> .....	<b>1</b>
The Owner's Handbook .....	1
Status at Time of Printing .....	1
Warranty.....	1
Symbols Used .....	2
In an Emergency.....	3
<b>Vehicle Identification Information</b> .....	<b>4</b>
Vehicle Identification .....	4
Vehicle Identification Label .....	5
<b>Instructions for Use of Electric Vehicle</b> .....	<b>7</b>
Effects of Ambient Temperature .....	7
Instructions for High Voltage Battery Pack Recycling .....	7
Driving Range.....	8
Equalisation Charging.....	9
Intelligent Charging * .....	9
Crash Outage Control .....	10
High Voltage System.....	10
Precautions in the Event of an Accident .....	12

# CONTENTS

---

<b>I Instruments and Controls .....</b>	<b>13</b>
<b>Instruments and Controls .....</b>	<b>14</b>
<b>Instrument Pack .....</b>	<b>16</b>
<b>Message Centre .....</b>	<b>17</b>
<b>Warning Lights and Indicators.....</b>	<b>29</b>
<b>Lights and Switches.....</b>	<b>40</b>
Master Light Switch.....	40
Headlamp Leveling Manual Adjustment.....	42
Direction Indicator/Main Beam Switch.....	43
Smart Main Beam System .....	44
Rear Fog Lamps.....	45
Hazard Warning Lamps .....	46
<b>Wipers and Washers.....</b>	<b>47</b>
Front Windscreen Wiper Operation.....	47
Rear Windscreen Wiper Operation.....	49
<b>Steering System .....</b>	<b>51</b>
Adjustment of Steering Column.....	51
Electric Power Steering .....	52

<b>Horn</b> .....	<b>53</b>
<b>Mirrors</b> .....	<b>54</b>
Door Mirrors.....	54
Interior Rearview Mirror .....	56
<b>Sunvisor</b> .....	<b>58</b>
<b>Windows</b> .....	<b>59</b>
Power Operated Window Switch .....	59
Window Operation.....	59
<b>Interior Light</b> .....	<b>62</b>
Front Interior Lamp .....	62
Automatic Operation .....	62
<b>Power Socket</b> .....	<b>63</b>
Front Console Power Socket.....	63
Rear Console USB Charging Ports * .....	64
<b>Storage Devices</b> .....	<b>65</b>
Instructions .....	65
Glove Box.....	65
Cubby Box.....	66

# CONTENTS

---

<b>Cup Holder</b> .....	<b>67</b>
Centre Console Cup Holder .....	67
Rear Armrest and Rear Cup Holder * .....	67
<b>Roof Luggage Rack</b> * .....	<b>68</b>
Maximum Authorised Load for the Roof.....	68
Periodical Check .....	68
<b>2 Air Conditioning</b> .....	<b>69</b>
<b>Ventilation</b> .....	<b>70</b>
Particle/Pollen Filter .....	71
Vents .....	71
<b>Electronic Temperature Control</b> * .....	<b>73</b>
Control Panel.....	73
Interface Display.....	74
Blower Speed Control.....	74
Economy Mode.....	74
Cooling On/Off Button .....	75
Temperature Control.....	75
Air Distribution Mode.....	75

Defrost/Demist .....	76
Heated Rear Window .....	76
Air Recirculation Mode .....	77
<b>Automatic Temperature Control *</b> .....	<b>78</b>
Control Panel.....	78
Interface Display.....	79
System On/Off.....	79
Auto Mode .....	79
Economy Mode.....	80
Cooling On/Off Button .....	80
Temperature Control.....	80
Blower Speed Control.....	81
Air Distribution Mode.....	81
Defrost/Demist .....	82
Heated Rear Window .....	82
Air Recirculation Mode .....	82
<b>3 Seats &amp; Restraints</b> .....	<b>85</b>
<b>Seats</b> .....	<b>86</b>
Overview .....	86

# CONTENTS

---

Head Restraints.....	86
Front Seats .....	87
Rear Seats.....	89
Front Seat Heating * .....	90
<b>Seat Belts .....</b>	<b>92</b>
Protection Provided by Seat Belts .....	93
Wearing Seat Belts .....	94
Children and Seat Belts .....	98
Seat Belt Pre-tensioners .....	99
Seat Belt Checks, Maintenance and Replacement.....	100
<b>Airbag Supplementary Restraint System .....</b>	<b>103</b>
Overview .....	103
Airbag Deployment.....	104
Conditions in Which Airbags Will Not Deploy .....	107
Service and Replacement of Airbags.....	108
Disposal of Airbags.....	109
<b>Child Restraints .....</b>	<b>111</b>
Important Safety Instructions about Using Child Restraints .....	111
Child Restraints Groups.....	113

Approved Child Restraint Positions .....	116
<b>4 Starting &amp; Driving .....</b>	<b>121</b>
<b>Keys .....</b>	<b>122</b>
Overview .....	122
Replacing the Key Battery.....	123
<b>Child Proof Locks .....</b>	<b>126</b>
<b>Anti-theft Systems .....</b>	<b>127</b>
Power Immobilisation .....	127
Body Anti-theft System .....	128
Tailgate.....	132
<b>Starting and Stopping the Power System .....</b>	<b>134</b>
START/STOP Switch .....	134
READY Mode.....	135
Switching the Power System OFF.....	137
<b>Pedestrian Alert System .....</b>	<b>138</b>
<b>Economical and Environmental Driving .....</b>	<b>139</b>
Running-in.....	139
Economic Driving and Maintenance .....	139

# CONTENTS

---

Driving in Special Environment.....	140
<b>Vehicle Control.....</b>	<b>141</b>
Vehicle Control System.....	141
Power Limit of Electrical Appliances.....	141
<b>Charging Requirements.....</b>	<b>142</b>
Charging Your Vehicle at Home.....	144
Installed Charging Points.....	144
Home Charging Guide.....	144
Charging and Medical Condition Awareness.....	145
Charging Port.....	145
Rapid Charging.....	148
Slow Charging.....	148
Charging Information.....	152
Equalisation Charging.....	153
Charging Times.....	153
<b>Electric Drive Transmission.....</b>	<b>157</b>
Instructions.....	157
Gear Shift Control.....	157
Vehicle Start-off.....	160



Driving on Hills .....	161
Driving Mode (MODE).....	161
Energy Regeneration (KERS).....	163
Protection Mode.....	165
<b>Brake System .....</b>	<b>167</b>
Foot Brake.....	167
Electronic Hydraulic Brake Application System (EHBS) .....	167
Hydraulic Booster Compensation System (HBC) .....	168
Cooperative Regenerative Braking System (CRBS).....	168
Electronic Brake Force Distribution (EBD) .....	169
Electronic Brake Assistance (EBA) .....	169
Anti-lock Brake System (ABS) .....	170
Hill Hold Control (HHC) .....	171
Auto Hold.....	173
Emergency Braking Hazard Warning Lights Control System (HAZ).....	175
Electronic Parking Brake (EPB).....	176
<b>Stability Control System (SCS) and Traction Control System (TCS).....</b>	<b>179</b>
<b>Tyre Pressure Monitoring System (TPMS).....</b>	<b>180</b>
<b>Cruise Control System * .....</b>	<b>182</b>

# CONTENTS

---

<b>Adaptive Cruise Control System *</b> .....	<b>185</b>
Adaptive Cruise Control System Activation .....	185
Adaptive Cruise Target Speed Adjustment .....	188
Adaptive Cruise Target Following Distance Adjustment .....	188
Adaptive Cruise Pause/Standby .....	189
Automatic Deactivation of Adaptive Cruise .....	189
Adaptive Cruise Override .....	189
Adaptive Cruise Resume .....	190
Clear Speed Memory .....	190
Adaptive Cruise Control System Impairment and Ineffectiveness .....	190
Special Driving Environments .....	191
<b>Driving Assist System *</b> .....	<b>194</b>
Description of Front View Camera .....	194
Description of Front Detection Radar .....	195
Speed Assist System .....	196
Lane Assist System .....	201
MG Pilot System .....	205
Forward Collision System .....	208
<b>Parking Aid</b> .....	<b>211</b>

Ultrasonic Sensor Parking Aid.....	211
Parking Camera .....	212
<b>Load Carrying .....</b>	<b>214</b>
Loadspace Loading.....	214
Internal Loading.....	214
<b>5 Emergency Information .....</b>	<b>217</b>
<b>Hazard Warning Devices.....</b>	<b>218</b>
Hazard Warning Lights .....	218
Warning Triangle.....	218
<b>eCall - SOS Emergency Assistance .....</b>	<b>219</b>
<b>Emergency Starting .....</b>	<b>221</b>
Using Booster Cables .....	221
Starting the Car .....	221
<b>Vehicle Recovery.....</b>	<b>224</b>
Towing Vehicle.....	224
Transporter or Trailer with Rope.....	227
<b>Tyre Repair and Wheel Replacement .....</b>	<b>228</b>
Tool Identification .....	228

# CONTENTS

---

Tyre Repair .....	228
Changing a Wheel * .....	231
<b>Fuse Replacement .....</b>	<b>235</b>
Fuse .....	235
Fuse Box .....	235
<b>Bulb Replacement .....</b>	<b>243</b>
Bulb Specification .....	243
Bulb Replacement .....	243
<b>6 Maintenance .....</b>	<b>253</b>
<b>Maintenance .....</b>	<b>254</b>
Routine Servicing .....	254
<b>Bonnet .....</b>	<b>257</b>
Opening the Bonnet .....	257
Closing the Bonnet .....	257
Bonnet Open Warning .....	257
<b>Front Compartment .....</b>	<b>259</b>
<b>Cooling System .....</b>	<b>260</b>
Coolant Check and Top Up-EDS .....	260

Coolant Check and Top Up-ESS .....	261
Coolant Specification .....	261
<b>Brake .....</b>	<b>263</b>
Brake Pads .....	263
Brake Fluid Check and Top Up .....	263
Brake Fluid Specification .....	264
<b>Battery .....</b>	<b>265</b>
Battery Maintenance .....	265
Battery Replacement .....	265
<b>High Voltage Battery Pack .....</b>	<b>267</b>
Precautions and restricted conditions for use of battery .....	267
<b>Washer .....</b>	<b>269</b>
Windscreen Washer Fluid Check and Top Up .....	269
Washer Nozzles .....	270
Washer Fluid Specification .....	270
<b>Wipers .....</b>	<b>271</b>
Wiper Blades .....	271
Replacing Front Windscreen Wiper Blades .....	272
Replacing Rear Wiper Blades .....	273

# CONTENTS

---

<b>Tyre</b> .....	<b>274</b>
Overview .....	274
Caring for Your Tyres .....	276
Tyre Wear Indicators .....	276
Replacement of Tyres .....	277
Wheel Fitment Rotation .....	277
Tyre/Snow Chains .....	278
<b>Cleaning and Vehicle Care</b> .....	<b>280</b>
Exterior .....	280
Cleaning the Interior.....	283
<b>7 Technical Data</b> .....	<b>285</b>
<b>Technical Data Dimensions</b> .....	<b>286</b>
<b>Weights</b> .....	<b>288</b>
<b>Parameters of Traction Motor</b> .....	<b>289</b>
<b>Recommended Fluids and Capacities</b> .....	<b>290</b>
<b>Wheel Alignment (Unladen)</b> .....	<b>291</b>
<b>Wheels and Tyres</b> .....	<b>291</b>
<b>Tyre Pressure (Cold)</b> .....	<b>291</b>

## Introduction

### The Owner's Handbook

This handbook describes all of the vehicles and standard equipment specification within the model range. Some of the information therefore, may not apply to your particular car.

Always remember that if you have any queries concerning the operation or specification of your car, your MG Authorised Repairer will be glad to advise you.

The illustrations in the Owner's Handbook are for reference only.

The information presented in this manual may vary slightly depending on vehicle configuration, software version and sales area.

### Status at Time of Printing

MG operates a policy of constant product improvement and therefore reserves the right to change specifications without notice at any time. Whilst every effort is made to ensure complete accuracy of the information in this publication, no liabilities for inaccuracies or the

consequences thereof, including loss or damage to property, or injury to persons, can be accepted by the manufacturer or MG Authorised Repairer who supplied the publication, except in respect of personal injury caused by the negligence of the manufacturer or MG Authorised Repairer .

### Warranty

Please consult [www.mg.co.uk](http://www.mg.co.uk) for the vehicle warranty terms and conditions, warranty statement and exemptions.

# PREFACE

---

## Symbols Used

The following symbols used within the handbook call your attention to specific types of information.

### Warning



*This warning symbol identifies procedures that must be followed precisely, or information that must be considered with great care, in order to reduce the risk of personal injury or serious damage to the car.*

### Important

IMPORTANT

The statements stated here must be followed strictly, otherwise your car could be damaged.

### Note

*Note: This describes helpful information.*



This symbol indicates that parts described must be disposed of by authorised persons or bodies to protect the environment.

### Asterisk

An asterisk (\*) appearing within the text, identifies features or items of equipment that are either optional, or are only fitted to some vehicles in the model range.

### Illustration Information



Identifies components being explained.



Identifies movement of components being explained.



**In an Emergency**

**IMPORTANT**

**Remember the breakdown safety code**

If a breakdown occurs while travelling:

- Wherever possible, consistent with road safety and traffic conditions, the car should be moved off the main thoroughfare, preferably into a lay-by. If a breakdown occurs on a motorway, pull well over to the inside of the hard shoulder.
- Switch on hazard lights.
- If available, position a warning triangle or a flashing amber light 50 to 150 metres (150 to 500 ft) behind your vehicle to warn approaching traffic. Note it is a legal requirement of some countries that a warning triangle is carried in the vehicle, if in doubt consult the local highways agency for further information.
- Consider evacuating passengers through nearside doors onto the verge to reduce risk of injury in the event of collision.

# PREFACE

---

## Vehicle Identification Information

### Vehicle Identification

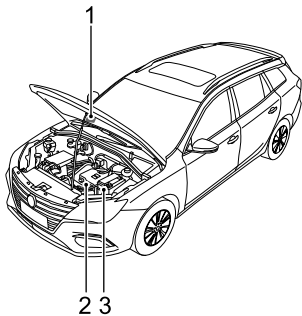

- 1 Vehicle Identification Number (VIN)
- 2 Drive Motor Number
- 3 Electric Drive Transmission Number

Always quote the Vehicle Identification Number (VIN) when communicating with MG Authorised Repairer. If the drive motor or electric drive transmission is involved, it

may be required to provide the identification numbers of these assemblies.

### Vehicle Identification Location

#### Vehicle Identification Number (VIN)

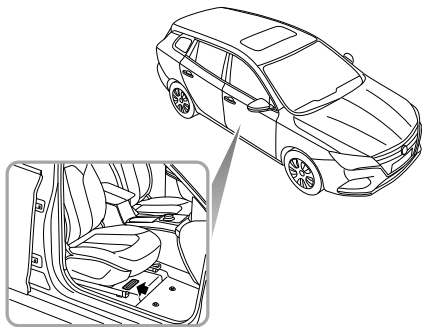

- On the floor under the driver's seat;
- On the identification plate;
- Stamped on a plate visible through the bottom right hand corner of the windscreen;

- On the inner side of the tailgate visible by opening the tailgate.

**Note: The DLC is located in the driver footwell at the base of the fascia panel on the RH side. The VIN information can be extracted from the vehicle using the approved diagnostic equipment.**

### **Drive Motor Number**

Stamped on the lower part of the drive motor housing.

### **Electric Drive Transmission Number**

Stamped on the upper part of the electric drive transmission housing.

### **Vehicle Identification Label**

The Vehicle Identification Label contains the following information:

- Type Approval Number
- Vehicle Identification Number (VIN)
- Gross Vehicle Weight
- Gross Train Weight
- Max Front Axle Weight
- Max Rear Axle Weight
- Model
- Engine Type

# PREFACE

---

## Location of Vehicle Identification Label

The Vehicle Identification Label is located at the lower side of driver side B pillar.

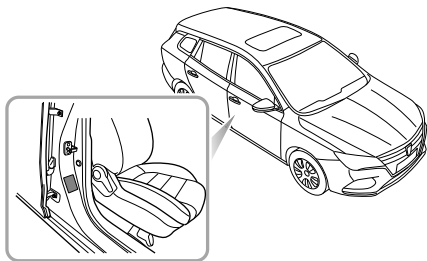

## Instructions for Use of Electric Vehicle

### Effects of Ambient Temperature

The working performance of the high-voltage battery pack fitted to your vehicle is related to the ambient temperature, this battery powers the vehicle power system and therefore it is recommended that where possible the vehicle should be used within the temperature range of -15 to 45°C. This will ensure that the vehicle is in the optimum working state, and help extend the service life of the high-voltage battery pack. Extremely high or low temperatures will affect the performance of the high-voltage battery pack and vehicle.

### Instructions for High Voltage Battery Pack Recycling

The high-voltage battery pack fitted to your vehicle contains several lithium based battery cells, it is installed centrally to the motor-vehicle chassis. Arbitrary disposal may cause pollution, hazard and damage to the environment. The high-voltage battery pack **MUST** be recycled by an MG Authorised Repairer or a professional

approved dismantling agent. Please refer to the following information and requirements.

- **ONLY** qualified personnel should work with the high voltage system - there is danger of DEATH.
- High voltage safety: the high voltage system fitted to your vehicle features a HV battery containing high voltage components such as lithium battery packs and high voltage wiring harness; **DO NOT** attempt to dismantle any area of this system, suitably trained professional staff must observe insulation safety protection before working on or near the high voltage system.
- Transportation: The high-voltage battery pack is classed as a Category 9 hazardous material and must be transported by vehicles qualified in transporting Category 9 hazardous materials.
- Storage: All HV components (including batteries) should be stored at room temperature and in a dry environment. They must be kept away from dangerous sources, such as flammable objects, heat and water sources.

# PREFACE

---

- Internal composition: The high-voltage battery pack consists of lithium batteries (pack), PCB, HV and normal electric wiring, metal casing and other components.

It is strongly recommended that the used high-voltage battery pack generated from vehicle scrappage or any other reasons should be disposed of by an MG Authorised Repairer. See official Website for details: [www.mg.co.uk](http://www.mg.co.uk).

**Note: If you decide not to use the recommended MG Authorised Repairer to dispose of your high voltage battery, the responsibility of the consequences of environmental pollution or accidents must be borne by the owner.**

## Driving Range

The driving range of your vehicle depends on the HV battery condition, quantity of available electricity, vehicle age (current remaining battery life), weather, temperature, road conditions and driving habit etc.

The range can be affected by other electrical loads (such as A/C, lights etc), driving style and general road conditions.

It should be noted that:

- The driving range is related to the rate of discharge. In order to avoid a high rate of discharge from affecting the performance of the high-voltage battery pack, it is recommended that the vehicle is connected to a suitable charger upon illumination of the low battery warning lamp in the instrument pack.
  - The actual driving range of vehicle will reduce with the increase of vehicle age.
  - The use of A/C will reduce the driving range.
  - The driving range varies at different speeds.
  - At low temperatures, the driving range will be reduced due to temperature characteristics of the battery during use.
  - In some instances of extreme temperatures and low battery voltage, you may experience insufficient acceleration or power reduction, this is due to battery characteristics.
- To help increase the range of the vehicle please observe the following:
- Have the vehicle regularly maintained as per service schedule.
  - Always ensure the tyre pressures are correct.

- Try and use the vehicle between the recommended ambient temperatures.
- Do not park or store the vehicle for long periods with a low state of charge, where possible charge the vehicle as soon as possible prior to storage.
- Remove unnecessary articles to reduce the vehicle load.
- Use of high power consuming systems such as A/C and heating will use large amounts of power, this will reduce the driving range.
- At a high speed, where possible, close the windows to reduce wind resistance and power consumption.
- Try to maintain a steady speed at all times, avoid constant acceleration and braking.
- During acceleration, apply the accelerator pedal as gently as possible.
- During deceleration, release the accelerator pedal; under certain conditions when not applying the brake or gently applying the brake, the energy regeneration system (KERS) will assist in charging the HV battery and extend the driving range.

### Equalisation Charging

In order to assist in extending the service life of the high voltage battery pack it is recommended that an equalisation charge is carried out at regular intervals.

Please see "Equalisation Charging" in the "Starting & Driving" section.

### Intelligent Charging \*

The 12V battery SOC is constantly monitored, when the Start/Stop switch is in the OFF position it is possible, under certain conditions, that the HV battery will automatically charge the 12V battery to ensure the vehicle starts. This function will activate and switch off automatically.

**Note: The system will suspend intelligent charging if a fault is present, when starting or the vehicle is being charged by an external device.**

**Note: The driving range will be reduced after intelligent charging.**

**Note: The intelligent charging function is suspended when the high voltage battery is in a low SOC.**

# PREFACE

---

## Crash Outage Control

If a crash or serious impact occurs, a signal from the SDM (Airbag Control Module) will disconnect the relays within the battery management system isolating the high voltage battery from the systems on the vehicle.

## High Voltage System



- *The high voltage system used on your vehicle features AC and DC voltages up to about 417V. All high voltage components have warning labels attached - please observe these warnings and any requirements when operating within or close to these areas.*
- *ONLY qualified personnel should work on, or with, the high voltage system - there is danger of DEATH.*



The high voltage system component layout is shown below:

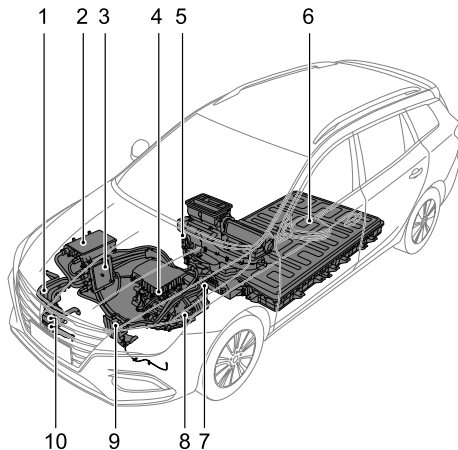

- 1 High Voltage Harness
- 2 Combined Charging Unit (CCU)
- 3 Power Distribution Unit (PDU)
- 4 Electric Drive Transmission
- 5 Electric Heater
- 6 High Voltage Battery (ESS)
- 7 Manual Service Disconnect (MSD)
- 8 Electric A/C Compressor
- 9 HV Battery Heater
- 10 Charging Port

# PREFACE

---

## Precautions in the Event of an Accident



- *Ensure the vehicle is in P, the parking brake is applied and the vehicle power system is OFF.*
- *If any cables on the vehicle are exposed, in order to prevent electric shock or even death DO NOT make any contact with any cable.*
- *If the vehicle catches fire, and the fire is small and slow, a carbon dioxide extinguisher can be used to extinguish the fire, and contact the fire services as soon as possible; if the fire is large and spreading quickly, immediately evacuate the vehicle and contact the fire services immediately.*
- *If the vehicle is involved in a collision and cannot be re-started, the negative cable of 12V battery and Manual Service Disconnect (MSD) MUST be disconnected prior to rescue.*
- *When the vehicle is completely or partially immersed in water, switch off the vehicle power system and evacuate the car immediately. The negative cable of 12V battery and Manual Service Disconnect (MSD) MUST be disconnected prior to rescue or as soon as the vehicle is refloated/removed from the water. Observe the water/vehicle for any abnormal signs such as excessive bubbles or noises, this may indicate battery short circuit issues, if no signs are evident there should not be a shock risk from the bodywork and recovery can commence.*
- *If your car is being recovered by an independent recovery agent, please contact MG Authorised Repairer for guidance.*
- *The vehicle is supplied with an emergency response information card. Please show the card to the rescue personnel when they arrive.*

## ***Instruments and Controls***

---

- |   |                               |
|---|-------------------------------|
| <i>14 Instruments and Controls</i>      | <i>65 Storage Devices</i>     |
| <i>16 Instrument Pack</i>               | <i>67 Cup Holder</i>          |
| <i>17 Message Centre</i>                | <i>68 Roof Luggage Rack *</i> |
| <i>29 Warning Lights and Indicators</i> |                               |
| <i>40 Lights and Switches</i>           |                               |
| <i>47 Wipers and Washers</i>            |                               |
| <i>51 Steering System</i>               |                               |
| <i>53 Horn</i>                          |                               |
| <i>54 Mirrors</i>                       |                               |
| <i>58 Sunvisor</i>                      |                               |
| <i>59 Windows</i>                       |                               |
| <i>62 Interior Light</i>                |                               |
| <i>63 Power Socket</i>                  |                               |

# INSTRUMENTS AND CONTROLS

---

## Instruments and Controls

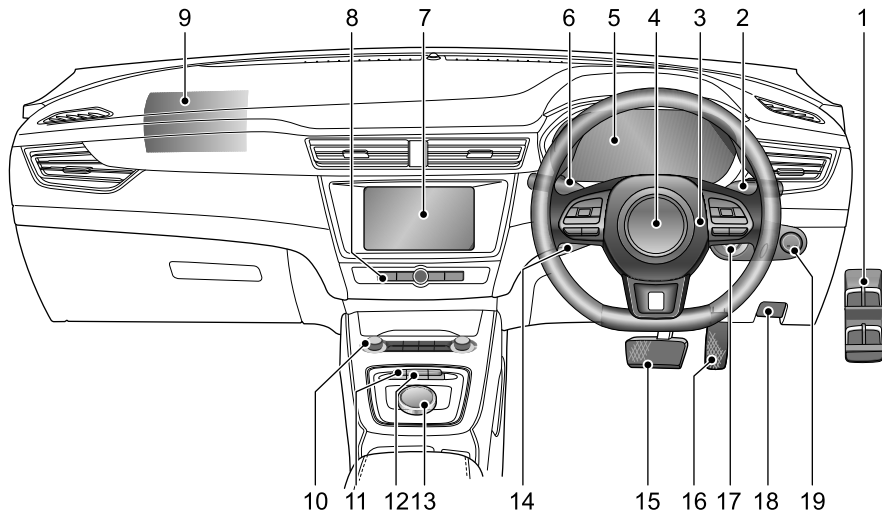

# INSTRUMENTS AND CONTROLS

---

- 1 Power Window Switch
- 2 Wiper Stalk Switch
- 3 Horn Button
- 4 Driver Airbag
- 5 Instrument Pack
- 6 Direction Indicator/Main Beam Stalk Switch
- 7 Onboard Entertainment System
- 8 Entertainment Controls
- 9 Front Passenger Airbag
- 10 Air Conditioning Controls
- 11 Driving Mode Selection Switch
- 12 Energy Regeneration (KERS) Selection Switch
- 13 Shift Control Knob
- 14 Cruise Control Stalk Switch
- 15 Brake Pedal
- 16 Accelerator Pedal
- 17 Headlamp Levelling and Mirror Adjustment Switch
- 18 Bonnet Release Handle
- 19 START/STOP Switch

# INSTRUMENTS AND CONTROLS

## Instrument Pack

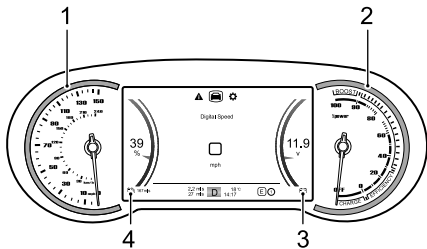

### Speedometer (1)

Indicates the vehicle speed in mph and km/h.

### Power Meter (2)

Indicates the power status of the power drive system as a percentage. The blue CHARGE segment indicates that the power drive system is converting part of the kinetic energy into electric energy; the green EFFICIENCY segment indicates that the vehicle is running using an economic

power output; the yellow BOOST segment indicates that the vehicle is running using a high power output.

### Electricity Meter of Low-voltage Battery (3)

Displays the voltage of low-voltage battery.

### Electricity Meter of High-voltage Battery Pack and Range to Empty (4)

Displays the current level of high voltage battery charge as a percentage and the remaining range of the vehicle before the high voltage battery becomes flat.

The high-voltage battery pack low battery warning lamp will illuminate when the high voltage battery charge is low. If the voltage continues to drop, this lamp will flash.

#### IMPORTANT

- When the high voltage battery indicator displays a low charge condition, connect to a charger and charge immediately.
- Before undertaking any journeys please ensure the high voltage battery contains enough power.

## Message Centre

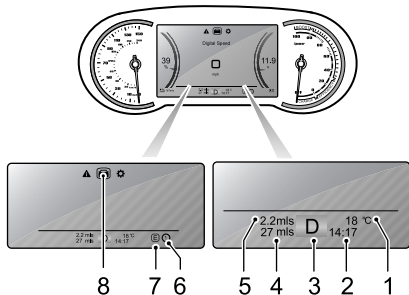

The message centre provides the following information:

- 1 Temperature
- 2 Digital Clock
- 3 Gear Display
- 4 Odometer

5 Trip Meter

6 Energy Regeneration Level

7 Driving Mode

8 Vehicle Information Display

## Temperature

Displays the current ambient temperature.

## Digital Clock

Displays the current time.

## Gear Display

Displays the current gear position (P, R, N, D).

If 'EP' is displayed, it indicates a serious functional failure with the gear shift system. In this case, please contact an MG Authorised Repairer immediately.

## Odometer

Displays the total distance the car has travelled.

# INSTRUMENTS AND CONTROLS

---

## Trip Meter

Displays the trip distance since reset.

## Energy Regeneration Level

Displays the current energy regeneration level of the vehicle. For more information, please refer to "Energy Regeneration (KERS)" in "Starting & Driving" section.

## Driving Mode

Displays the current driving mode of the vehicle. For more information, please refer to "Driving Mode (MODE)" in "Starting & Driving" section.

## Vehicle Information Display

With the START/STOP Switch in the ON/READY position, the vehicle information display function can be selected as follows:

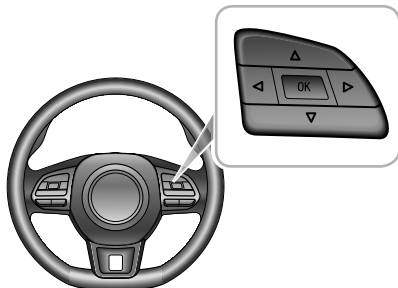

- Press the UP/DOWN/LEFT/RIGHT button in the RH steering wheel multifunction switch pack, this will access and display the general information options.
- Press the UP/DOWN button in the RH steering wheel multifunction switch pack to scroll through the options.
- Press the OK button in the RH steering wheel multifunction switch pack to confirm your option selection or long press the OK button to reset.



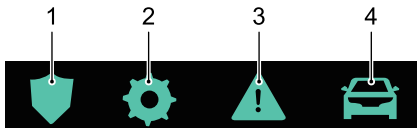

The vehicle information display contains the following information:

- 1 Active Safety \*
- 2 Setting
- 3 Warning Information
- 4 Trip Computer

### **Active Safety \***

Displays the active safety information of the vehicle.

For more information, please refer to “Adaptive Cruise Control System” and “Driving Assist System” in “Starting & Driving” section.

### **Setting**

### **Luminance Level**

Displays the current level and allows adjustment of the backlight brightness.

### **OverSpeed Threshold**

Allows the setting of the over-speed alarm threshold, please note, the over-speed alarm function is turned off when "OFF" is displayed.

### **Next Service \***

Displays the current vehicle maintenance information.

### **Warning Information**

Displays any warning information or important notes that are currently relevant to the vehicle.

### **Trip Computer**

The trip computer function contains the following:

- Energy Flow
- Digital Speed: displays the current vehicle speed.

# INSTRUMENTS AND CONTROLS

---

- **Current Journey:** displays the range, duration, average speed and average power consumption since startup. It can be reset by long pressing the "OK" button in the RH steering wheel multifunction switch pack.
- **Accumulated Total:** displays the range, duration, average speed and average power consumption since the last reset. It can be reset by long pressing the "OK" button in the RH steering wheel multifunction switch pack.
- **Electric Information:** displays the current operation state of the vehicle, including the voltage, current and motor speed.
- **TPMS Monitor:** Displays the current tyre pressures and temperatures.

## **Energy Flow**

The energy flow interface automatically switches between display graphics to depict the current drive state. The display reverts to the default screen that displays no power flow when the vehicle power system is switched to the READY state. Other modes are as follows.

### **Energy Regeneration Mode**

The motor recycles kinetic energy to charge the high-voltage battery pack.

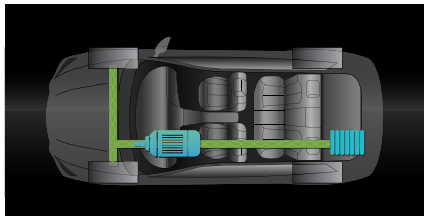

## Electric Drive Mode

The vehicle is driven by motor.

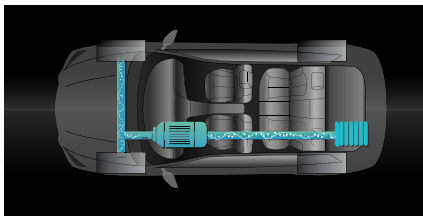

## Warning Message

Warning messages and prompts are displayed in the information message centre in the instrument pack. Any communications are displayed in 'pop up' messages, these can be divided into the following categories:

- Operation Instruction
- System State Instruction
- System Malfunction Alert

Please follow the instructions displayed in the 'pop up' message or in the case of a warning message, please refer to the relevant section of the owners manual to follow the correct instructions.

The following are a selection of warning messages that may appear in the information message centre.

## INSTRUMENTS AND CONTROLS

---

Warning Message	Action
Cruise Control System Fail	Indicates that the cruise control system has detected a fault. Please contact an MG Authorised Repairer as soon as possible.
Ignition System Fault	Indicates that the power mode has detected a fault. Please contact an MG Authorised Repairer immediately.
Start Stop Button Fail	Indicates that the START/STOP Switch has detected a fault. Please contact an MG Authorised Repairer immediately.
Passive Entry Fault	Indicates that the passive keyless entry function has detected a fault. Please contact an MG Authorised Repairer as soon as possible.

Warning Message	Action
ABS Fail	Indicates that the anti-lock brake system (ABS) has detected a fault, and the ABS function is about to be disabled. Please contact an MG Authorised Repairer immediately.
Brake Fail	Indicates that a fault has been detected within the braking system, such as brake fluid low/loss or Electronic Brake-force distribution failure has occurred, stop the vehicle as soon as safety permits switch the vehicle power system OFF, check the brake fluid level and contact an MG Authorised Repairer immediately.

## INSTRUMENTS AND CONTROLS

1

Warning Message	Action
Stability Control System Fail	Indicates that the dynamic stability control system (SCS) has detected a fault. Please contact an MG Authorised Repairer immediately.
Traction Control System Fail	Indicates that the traction control system (TCS) has detected a fault. Please contact an MG Authorised Repairer immediately.
Park Brake Force Not Enough	Indicates that the electronic parking brake system has detected a fault when parking. Please contact an MG Authorised Repairer as soon as possible.
Autohold Fail	Indicates that the auto hold function has detected a fault. Please contact an MG Authorised Repairer as soon as possible.

Warning Message	Action
EPS Performance Decrease	Indicates that the electric power steering system (EPS) has a general failure and the performance is reduced. As soon as conditions permit, safely stop the vehicle and switch the vehicle power system to the OFF position. After a short while, switch the vehicle power system to the READY position, drive the vehicle a short distance and monitor the operation of the steering, if the message is still displayed or the steering assistance reduced please contact an MG Authorised Repairer immediately.

## INSTRUMENTS AND CONTROLS

---

Warning Message	Action
Power Steering System Fault	Indicates that the electric power steering system (EPS) has failed. Please contact an MG Authorised Repairer immediately.
Steering Angle Sensor Fault	Indicates that the steering angle sensor has failed. Please contact an MG Authorised Repairer as soon as possible.
SAS Uncalibrated See Handbook	Indicates that the steering angle sensor is not calibrated. Please contact an MG Authorised Repairer as soon as possible.
ESCL Fault	Indicates that the ESCL system has detected a fault. Stop the car as soon as safety permits, shut down the engine and contact an MG Authorised Repairer immediately.

Warning Message	Action
Park Aid System Fault	Indicates that PDC system has detected a fault. Please contact an MG Authorised Repairer as soon as possible.
Airbag Fault	Indicates that the SDM has detected a fault. As soon as conditions permit, safely stop the vehicle and switch the vehicle power system to the OFF position and contact an MG Authorised Repairer immediately.
Airbag Lamp Fail	Indicates that the airbag lamp has failed. Please contact an MG Authorised Repairer as soon as possible.

## INSTRUMENTS AND CONTROLS

1

Warning Message	Action
Tyre Pressure Monitoring Fail	Indicates that the tyre pressure monitoring system (TPMS) has detected a fault. Please contact an MG Authorised Repairer as soon as possible.
Front Left/Front Right/Rear Left/Rear Right Tyre Sensor Battery Low	Indicates that the TPMS has detected a sensor has a low battery. Please contact an MG Authorised Repairer as soon as possible.
Pedestrian Alert System Fault	Indicates that the pedestrian alert system has detected a fault. Please contact an MG Authorised Repairer as soon as possible.
DCDC Charge Fault	Indicates that the CCU has detected a fault. Please contact an MG Authorised Repairer immediately.

Warning Message	Action
12V Battery Charging System Fault	Indicates that the 12V battery charging system has detected a fault. Please contact an MG Authorised Repairer immediately.
Check HV Battery	Indicates that the HV battery has detected a fault. Please contact an MG Authorised Repairer immediately.
Escape from the vehicle immediately!	As soon as conditions permit, safely stop the vehicle and evacuate all occupants immediately, and contact an MG Authorised Repairer immediately.
System Fault	Indicates that the power system has detected a fault. Please contact an MG Authorised Repairer as soon as possible.

## INSTRUMENTS AND CONTROLS

---

Warning Message	Action
Motor Overheating	Indicates that the motor has overheated. Please contact an MG Authorised Repairer as soon as possible.
EDU Coolant Overheating	Indicates that the EDS coolant has overheated. Please contact an MG Authorised Repairer as soon as possible.
Motor Fault	Indicates that the drive motor has detected a fault. As soon as conditions permit, safely stop the vehicle and switch the vehicle power system to the OFF position and contact an MG Authorised Repairer immediately.

Warning Message	Action
eCall System Fault Consult Handbook	Indicates to the driver via a yellow SOS warning lamp that the eCall system has detected a fault and is not operating within its parameters. The SOS button LED status indicator flashes twice per second. Please contact an MG Authorised Repairer as soon as possible.
eCall System Failure Consult Handbook	Indicates to the driver via a red SOS warning lamp that the eCall system has failed and is not capable of supporting in the event of an accident. The SOS button LED status indicator is not illuminated. Please contact an MG Authorised Repairer immediately.



## INSTRUMENTS AND CONTROLS

1

Warning Message	Action
eCall in Progress	Indicates to the driver via a green SOS warning lamp that an emergency services call is currently in progress. The SOS button LED status indicator flashes once per second.
Auto eCall Disabled Consult Handbook	Indicates to the driver via a red SOS warning lamp that automatic eCall service is disabled. Please contact an MG Authorised Repairer to reactivate the automatic eCall function.
Front Camera System Fault Consult Handbook	It indicates that the front camera has detected a fault. Please contact an MG Authorised Repairer as soon as possible.

Warning Message	Action
Front Camera Calibration Failed	Indicates that the front view camera module (FVCM) calibration has failed. Please contact an MG Authorised Repairer as soon as possible.
RADAR Calibration Failed	Indicates that the radar module calibration has failed. Please contact an MG Authorised Repairer as soon as possible.
Lane Departure Warning System Fault Consult Handbook	Indicates that the lane departure warning system (LDW) has detected a fault. Please contact an MG Authorised Repairer as soon as possible.
Lane Keep Assist System Fault Consult Handbook	Indicates that the lane keep assist system (LKA) has detected a fault. Please contact an MG Authorised Repairer as soon as possible.

## INSTRUMENTS AND CONTROLS

---

Warning Message	Action
MG Pilot System Fault Consult Handbook	Indicates that the MG pilot system has detected a fault. Please contact an MG Authorised Repairer as soon as possible.
Auto Emergency Braking System Fault Consult Handbook	Indicates that the auto emergency braking system (AEB) has detected a fault. Please contact an MG Authorised Repairer as soon as possible.
Forward Collision System Fault Consult Handbook	Indicates that the forward collision warning system (FCW) has detected a fault. Please contact an MG Authorised Repairer as soon as possible.
Manual Speed Assist Fault Consult Handbook	Indicates that the Manual Speed Assist (MSA) function has failed. Please contact an MG Authorised Repairer as soon as possible.

Warning Message	Action
Intelligent Speed Assist Fault Consult Handbook	Indicates that the Intelligent Speed Assist (ISA) function has failed. Please contact an MG Authorised Repairer as soon as possible.
ACC System Fault Consult Handbook	Indicates that the adaptive cruise control system (ACC) has detected a fault. Please contact an MG Authorised Repairer as soon as possible.

## Warning Lights and Indicators

Some warning lamps illuminate or flash accompanied by a warning tone. Certain warning lamps will be accompanied by a momentary warning symbol and text message displayed in the information centre in the instrument pack.

### Main Beam Indicator - Blue



This indicator illuminates when the headlamp high beam is turned on.

### Auto Main Beam Indicator - Green \*



The indicator illuminates when the auto main beam function is enabled.

### Side Lamp Indicator - Green



This indicator illuminates when the side lamps are on.

### Rear Fog Lamp Indicator - Yellow



This indicator illuminates when the rear fog lamps are on.

### Direction Indicators - Green



The left and right direction indicator lamps are represented by directional arrows that are located at the top of the instrument pack. When the turning signal lamp flashes, the direction indicator lamp on the corresponding side also flashes. If the hazard warning lamps are operated, both direction indicator lamps will flash together. If either direction indicator lamp in the instrument pack flashes very rapidly, it indicates that the turning signal light on the corresponding side has failed.

**Note:** *Failure of a side repeater lamp will have no effect on the flash frequency of direction indicator lamp.*

# INSTRUMENTS AND CONTROLS

---

## Airbag Warning - Red



If this lamp illuminates, it indicates that the SRS or the seat belt has failed. As soon as conditions permit, safely stop the vehicle and switch the vehicle power system to the OFF position and contact an MG Authorised Repairer immediately. An SRS or seat belt fault may mean the components may not be deployed in the event of an accident.

## Seat Belt Unfastened Warning Lamp - Red



If this lamp illuminates or flashes, it indicates that the seat belt for the driver or front passenger remains unfastened.



This vehicle is equipped with rear seat belt warnings to remind you to ensure any rear seat passengers have fastened their seat belts. The dedicated warning lamp consists of the 3 sections, 1 for each rear seat position, it will illuminate red on every ignition cycle and remain

illuminated until a pre-set speed is reached and after a pre-set time period. If all 3 rear seat belts are fastened this lamp will extinguish immediately. When each individual rear seat belt is fastened the colour of that particular seat belt warning lamp will change from red to grey, the other seat positions will remain illuminated red, all 3 seat belt warning lamps will extinguish after the pre-set speed is reached and the pre-set time has been surpassed.

## Cruise Control Indicator - Green/Yellow \*



If the cruise control is switched on, the system will enter into standby state, and the indicator illuminates in yellow.

When the cruise control system operates, this indicator illuminates green, indicating the cruise control system is activated.

If a fault in the cruise control system is detected, the indicator will flash in yellow. Please seek an MG Authorised Repairer urgently.

## Low-voltage Battery Charging System Malfunction Warning - Red



When the vehicle power system is switched to the ON position this lamp illuminates as part of a self test, when the system is switched to READY the warning light will extinguish. If the warning light illuminates whilst driving contact an MG Authorised Repairer at the earliest opportunity.

If the battery power is low, this lamp illuminates and a prompt message appears in the information centre. In this case, the system will restrict or turn off some electrical devices, please ensure the vehicle power system is in READY mode to charge the battery.

## Stability Control/Traction Control System Operation and Fault Warning - Yellow



If this lamp illuminates, it indicates that the stability control system/traction control system has

detected a fault. Please contact an MG Authorised Repairer immediately.

If this lamp flashes while driving, it indicates that the system is operating to assist the driver.

## Stability Control/Traction Control System OFF Warning - Yellow



If the stability control system/traction control system is switched off manually, this warning lamp will illuminate.

## ABS Warning - Yellow



If this lamp illuminates, it indicates that the ABS has detected a fault. Please contact an MG Authorised Repairer immediately.

If an ABS failure occurs while driving, the ABS function will be disabled while normal braking will still be available. Please contact an MG Authorised Repairer immediately.

# INSTRUMENTS AND CONTROLS

---

## **Booster System / Brake System Warning -**

### **Yellow/Red**



If the booster system detects a fault, this lamp illuminates yellow, please slow down, stop the vehicle as soon as safety permits and contact an MG Authorised Repairer immediately.

If the booster system or brake system suffers a serious failure, or the brake fluid level drops below the minimum level, this lamp illuminates red, stop the vehicle as soon as safety permits, turn off the START/STOP Switch and contact an MG Authorised Repairer immediately.

## **Electric Power Steering (EPS)/ Electric Steering Column Lock (ESCL) Warning - Yellow/Red**



The warning lamp is used to indicate electric power assisted steering failure or electronic steering column lock failure.

If this lamp illuminates yellow, it indicates the electric power assisted steering system has a general failure and the performance is reduced. Please stop the car as soon as safety permits. If the lamp still illuminates after restarting the vehicle and driving for a short while, please contact an MG Authorised Repairer immediately.

If this lamp illuminates red, it indicates the electric power assisted steering system has a general failure relevant to steering angle sensing. Please contact an MG Authorised Repairer as soon as possible.

If this lamp illuminates red and flashes, it indicates the electric power assisted steering system has a severe failure. Please contact an MG Authorised Repairer immediately.

If the lamp illuminates yellow and continually flashes accompanied with an audible warning, it indicates the electric steering column lock has detected a fault or failed. Please contact an MG Authorised Repairer as soon as possible. If this lamp extinguishes after flashing for a while, it indicates that the steering wheel is locked,

please attempt to rotate the steering wheel to remove any adverse loads.

### **Tyre Pressure Monitoring System (TPMS)**

#### **Warning - Yellow**



If this warning lamp illuminates it indicates that a tyre pressure is low, please check the tyre pressures.

If this lamp flashes first and then remains illuminated after a period of time, it indicates the system has detected a fault. Please contact an MG Authorised Repairer as soon as possible.

#### **Immobiliser System Warning - Red**



If no valid key is detected, this lamp will illuminate red. Please use the correct key, or put the smart key at the bottom of the centre console cup holder. For specific location requirements, refer to "Alternative Starting Procedure" in "Starting & Driving" section.

With the START/STOP Switch in the ON/READY position, if remote key battery is low, this lamp flashes, please replace the battery as soon as possible.

With the START/STOP Switch in the OFF position, the lamp flashes if the vehicle is fully armed or partially armed with security system.

### **Electronic Parking Brake (EPB)/ Auto Hold Status Indicator - Red/Green**



If this lamp illuminates red, it indicates the EPB system is enabled. If this lamp illuminates red and flashes, it indicates that the EPB system has failed. Please contact an MG Authorised Repairer as soon as possible.

When the auto hold system is operating to assist the driver, this lamp illuminates green.

# INSTRUMENTS AND CONTROLS

---

## Electronic Parking Brake (EPB) System Malfunction Warning - Yellow



If an EPB system failure is detected or the system is under diagnosis, this lamp will illuminate. Please contact an MG Authorised Repairer as soon as possible.

## READY Indicator - Green



This lamp is used to indicate that the vehicle is ready for driving.

## Charging Status Indicator - Yellow



This lamp will illuminate when the vehicle is connected to a charge point, it will remain on during charging and extinguish after charging is completed.

## Charging Connection Indicator - Red



This lamp will illuminate when the vehicle is connected to a charge point.

## Power System Malfunction Warning - Red



This lamp will illuminate if a power system failure is detected. Please contact an MG Authorised Repairer as soon as possible.

## Motor Overheat Warning - Red



This lamp will illuminate if the motor temperature is too high. Please contact an MG Authorised Repairer as soon as possible.

## Motor Malfunction Warning - Red



If a fault or failure is detected in the motor or the power electronic box of electric drive system, this lamp



will illuminate. Please stop the vehicle as soon as safety permits, turn off the START/STOP Switch and contact an MG Authorised Repairer immediately.

## **High-voltage Battery Pack Low Battery Warning - Yellow**



This lamp will illuminate when the high voltage battery charge is low, if the voltage continues to drop, this lamp will flash. Where possible please charge the high voltage battery before this lamp enters the flashing stage.

## **High-voltage Battery Pack Disconnection Warning - Yellow**



When the high-voltage battery pack is connected, this lamp will not illuminate. This lamp will only illuminate when the high voltage battery is disconnected or isolated.

## **High-voltage Battery Pack Malfunction Warning**

### **- Red**



This lamp will illuminate if a fault is detected or the high voltage battery fails. Please contact an MG Authorised Repairer immediately.

This lamp will flash if the high voltage battery temperature is too high. Please stop the car as soon as safety permits, switch the vehicle power system to the OFF position, and leave the vehicle immediately. Contact an MG Authorised Repairer at the earliest opportunity.

If a high-voltage battery pack relay adhesion failure is recorded, this lamp flashes. Please contact an MG Authorised Repairer as soon as possible.

## **Driving Power Limited Warning - Yellow**



This lamp will illuminate if the vehicle power has been reduced.

# INSTRUMENTS AND CONTROLS

---

## eCall SOS Indicator - Red/Yellow/Green



If the system is ready and an emergency services call (eCall) is in progress, the indicator illuminates green.

If the system is still capable of sending out a vehicle information message to the call centre, but other eCall capabilities are limited due to a fault in the system, the indicator will illuminate yellow. If the eCall system has failed and not operational, the indicator illuminates red. If the yellow or red indicator is illuminated permanently after system self-test, please contact an MG Authorised Repairer immediately.

## System Fault Messages Indicator - Yellow/Red \*



This indicator is used to alert the driver of a stored warning. Please refer to "Message Centre" in this section for these failures.

## Lane Assist System Indicator - Green/Yellow \*



This lamp will illuminate yellow when the lane departure warning function is enabled, the lamp will extinguish when the function is disabled. This lamp will illuminate green when the function is activated.



This lamp will illuminate yellow when the lane departure prevention function or lane keeping assist function is enabled, the lamp will extinguish when the function is disabled. This lamp will illuminate green when the function is activated.

If the Lane Assist System is not able to function normally, the corresponding lamp will flash yellow and then remain on after a period of time. Should this warning persist, please contact an MG Authorised Repairer.

For more information, please refer to "Lane Assist System" in "Starting & Driving" section.

## MG Pilot System Indicator - Green/Yellow \*



This lamp will illuminate yellow when the MG Pilot function is enabled, the lamp will extinguish when the function is disabled.

This lamp illuminates green when the MG Pilot function is activated.

If the MG Pilot System is not able to function normally the lamp will flash yellow and then remain on after a period of time. Should this warning persist, please contact an MG Authorised Repairer.

For more information, please refer to “MG Pilot System” in “Starting & Driving” section.

## Forward Collision System Indicator - Yellow \*



This lamp will illuminate yellow when one of the forward collision system functions is disabled.

When all of the forward collision system functions are enabled, if the indicator remains on, it indicates the system

is not able to function normally. Please contact an MG Authorised Repairer as soon as possible.

For more information, please refer to “Forward Collision System” in “Starting & Driving” section.

## Manual Speed Assist System Indicator - White/Green/Yellow \*



This lamp will illuminate white when the Manual Speed Assist function is enabled.

This lamp illuminates green when the Manual Speed Assist function is activated.

'NNN' denotes the current setting value of the speed limit. If there is no speed limit value the lamp will display '—'.

If the Manual Speed Assist System is not able to function normally the lamp will flash yellow and then extinguish. Please try to reinstate this function. If this function cannot be switched on, please contact an MG Authorised Repairer as soon as possible.

# INSTRUMENTS AND CONTROLS

---

For more information, please refer to “Speed Assist System” in “Starting & Driving” section.

## Intelligent Speed Assist System Indicator - Green/Yellow \*



This lamp will illuminate yellow when the Intelligent Speed Assist function is enabled.

This lamp illuminates green when the Intelligent Speed Assist function is activated.

If the Intelligent Speed Assist System is not able to function normally the lamp will flash yellow and then extinguish. Please try to reinstate this function. If this function cannot be switched on, please contact an MG Authorised Repairer as soon as possible.

For more information, please refer to “Speed Assist System” in “Starting & Driving” section.

## Speed Limit Sign Indicator - Red \*



'NNN' denotes the speed value of speed limit sign currently recognised. If there is no speed limit value available the lamp will display '—'.

When the Intelligent Speed Assist function is activated or Speed Limit Information Function (SLIF) is enabled, the lamp will flash if the speed limit value is exceeded, please slow down.

For more information, please refer to “Speed Assist System” in “Starting & Driving” section.

## Speed Limit Sign Additional Information Warning Lamp- Yellow \*



This lamp will illuminate when the speed limit sign currently recognised has additional information. Please pay attention to it.

For more information, please refer to “Speed Assist System” in “Starting & Driving” section.

### National Speed Limit Sign Indicator \*



When the national speed limit sign is identified, and the speed limit information function or intelligent speed assist function is enabled, this lamp illuminates.

For more information, please refer to “Speed Assist System” in “Starting & Driving” section.

### Adaptive Cruise Control System Indicator - Yellow/Green \*



If the Adaptive Cruise function is enabled, the Adaptive Cruise Control System will enter the standby state, the lamp illuminates yellow.

When the Adaptive Cruise Control System operates, the lamp will illuminate green, this indicates that the Adaptive Cruise Control System is activated.

### Adaptive Cruise Control System Malfunction Indicator Lamp - Yellow \*



This lamp will illuminate if a Adaptive Cruise Control System failure is detected. Please contact an MG Authorised Repairer as soon as possible.

**Note:** *There are some circumstances where a warning light may illuminate or a warning message is displayed as an indication of an issue with the associated system, this does not necessarily indicate a fault. If in doubt, please seek advice from an MG Authorised Repairer.*

# INSTRUMENTS AND CONTROLS

## Lights and Switches

### Master Light Switch

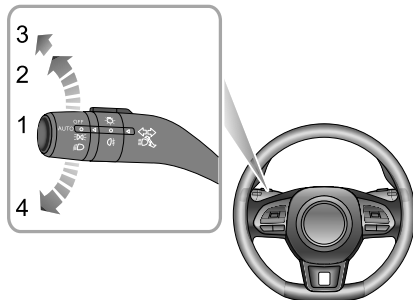

- 1 AUTO Lamp
- 2 Side Lamp and Switch Illumination
- 3 Dipped Headlamps
- 4 Lamps Off

### AUTO Lamp

When the START/STOP Switch is in the ACC position, the auto lighting system defaults to the ON position (1). The AUTO lighting system will automatically switch the side lamps and switch illumination on and off according to the intensity of current ambient light.

With the START/STOP Switch in the ON/READY position, the AUTO lighting system will automatically switch the side lamps, switch illumination and dipped beam headlamps on and off according to the intensity of current ambient light.

### Side Lamp and Switch Illumination

Rotate the master light switch to position 2 to switch on the side lamps and switch illumination. For some models, when the START/STOP Switch is in position ON/READY and only the side lamps are on, the headlamps will illuminate the daytime running lamps to supplement the light source. With the START/STOP Switch in the OFF position, if the side lamps are left switched on when the driver's door is opened, an audible alarm will sound.

## Headlamps

When the START/STOP Switch is in the ON/READY position, rotate the master light switch to position 3 to switch on the dipped beam headlamps and side lamps.

## Lamps Off

Rotate the master light switch to position 4 to switch off the lamps. Releasing the switch will allow it to return to the AUTO switch position

## Follow Me Home

After the START/STOP Switch is turned off, pull the light lever towards the steering wheel. This will enable the Follow Me Home function, dipped beam headlamps and side lamps will illuminate depending upon the vehicle configuration. For some models, it can be set on the entertainment display.

## Daytime Running Lamps

The daytime running lamps illuminate automatically when the START/STOP Switch is in the ON/READY position.

When the dipped headlamps are switched on, the daytime running lamps extinguish automatically

## Find My Car

After the vehicle has been left in a locked condition in excess of 2 minutes, pressing the lock button again on the remote key will enable the Find My Car function. This function will identify the car by means of an audible and visual alert. Pressing the Lock button on the handset again will suspend this operation. Pressing the Unlock button will cancel this operation. Find My Car can be set on the infotainment display.

# INSTRUMENTS AND CONTROLS

## Headlamp Leveling Manual Adjustment

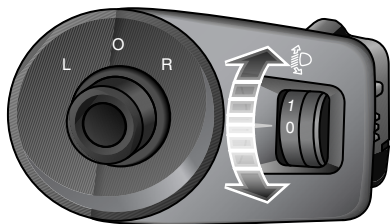

Position 0 is the initial position of the headlamp levelling adjustment switch. The headlamp leveling can be adjusted as per the following table according to the vehicle load.

Location	Load
0	Driver, or driver & front passenger
1	All the seats occupied with no load in the bootspace
2	All the seats occupied plus an evenly distributed load in the bootspace
3	Driver only, plus an evenly distributed load in the bootspace



## Direction Indicator/Main Beam Switch



**Take care not to dazzle oncoming vehicles when driving using main beam headlamps.**

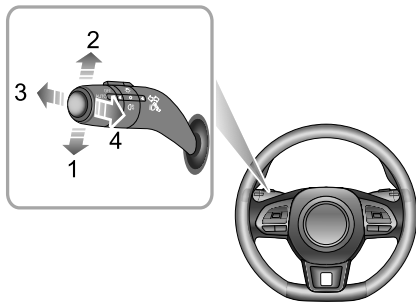

### Direction Indicators

Move the light stalk switch down to indicate a LEFT turn (1). Move the light stalk switch up to indicate a RIGHT turn (2). The corresponding GREEN direction indicator in

the instrument pack will flash when the turn signal lamps are working.

Rotating the steering wheel will cancel the indicator operation (small movements of the steering wheel may not operate the self cancelling). To indicate a lane change, move the lever briefly and release, the indicators will flash three times and then cancel.

### Main/Dipped Beam Headlamps Switching

With the START/STOP Switch in the ON/READY position and the headlamps on, push the light stalk switch towards the instrument panel (3) to turn on main beams. At this time, the main beam indicator in the instrument pack will illuminate and the message centre will prompt "Main Beam On". Push the light stalk switch (3) once again to switch to dipped beams.

### Main Beam Flash

To briefly flash the main beam on and off, pull the lever towards the steering wheel (4) and then release.

# INSTRUMENTS AND CONTROLS

---

## Smart Main Beam System



*The smart main beam system serves only as an auxiliary function. The driver still needs to check the status of the front lamps, and turn on the front lamps when necessary.*

*For example: The main beam may not be turned off automatically in the following cases, thus manual switching between the main beam and dipped beam is required:*

- The windscreen is dirty, broken or obstructed by other objects blocking the view of the sensor.*
- The lamps of other vehicles are missing, damaged, blocked or partially blocked or cannot be detected for some other reasons.*
- The lamps of other vehicles are obscured or partially obscured by smoke, fog, snow, water spray or any other conditions that effect visibility.*

- When pedestrians, non-motor vehicles and other objects with no obvious light or reflected light are encountered.*
- When the headlamps and tail lamps of other vehicles cannot be detected due to the sensor view being impaired due undulating road conditions such as bends, dips or hills.*
- When the car is driving on a winding or mountainous road.*

*In any of the aforementioned conditions (but not limited to) smart main beam operation may be suspended, it will be necessary to operate the main beam lamps manually.*

The smart main beam system uses the front view camera to detect the light intensity of the vehicle ahead. The main beam lamps can be switched on or off automatically by the system when the surroundings are dark and no light detected.

To enable the smart main beam system, the following conditions should be met:

- 1 The master lighting switch must be in the 'AUTO' position and the dipped beam lamps switched on via automatic control.
- 2 The vehicle is running and the speed is above 25 mph(40 km/h).

When the smart main beam system is enabled, the auto main beam indicator on the instrument pack illuminates.

The main beam lamps will remain on under automatic control until any of the following conditions occur:

- The system detects the headlamps of approaching vehicles.
- The system detects the tail lamps of vehicles ahead.
- The surroundings become bright enough not to require main beam.
- The vehicle speed drops below the 25 mph(40 km/h) threshold.

The system will temporarily suspend the smart main beam function once the following conditions are met:

With the smart main beam system enabled, instantaneously pull the lighting lever towards the steering wheel, the smart

main beam function will be temporarily suspended and it will automatically be re-instated after the switch is released.

**Note:** *Continuously operating the main beam switch within 2 seconds will retain the main beam lamps under automatic control, and the system will not exit the smart main beam function.*

## IMPORTANT

The smart main beam function uses data from the front view camera, always keep the windscreen clean and free from residue in this area to maintain optimum performance of this system. Any damage in this area, such as stonechips must be repaired at the earliest convenience.

## Rear Fog Lamps



***Fog lights should only be used when visibility is below 100m - other road users could be dazzled in clear conditions.***

# INSTRUMENTS AND CONTROLS

---

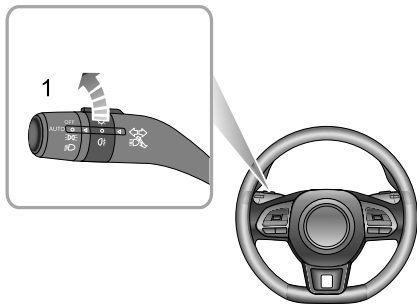

With the START/STOP Switch in the ON/READY position and the headlamps on, rotate the fog lamp switch to position 1 to turn on the rear fog lamps. The rear fog lamp indicator illuminates in the instrument pack when the rear fog lamps are on.

**Note:** *The rear fog lamps will turn off automatically when the master light switch is switched off.*

## Hazard Warning Lamps

Press the hazard warning lamp button  to turn on the hazard warning lamps. At this time, all turn signal lamps and direction indicators will flash together. Press the button again to turn off the hazard warning lamps. All turn signal lamps and direction indicators will stop flashing.

## Wipers and Washers

### Front Windscreen Wiper Operation

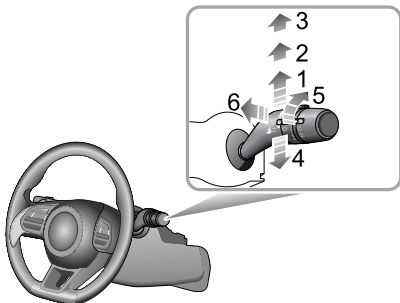

The front wipers and washers will only operate when the START/STOP Switch is in the ON/READY position. Operate the stalk switch to select different wiping modes:

- Intermittent wipe (1)
- Slow wipe (2)

- Fast wipe (3)
- Single wipe (4)
- Rain sensor sensitivity adjustment (5)
- Programmed wipe (6)

### Intermittent Wipe

By pushing the lever up to the Intermittent wipe position (1), the wipers will operate automatically.

Vehicles are equipped with a rain sensor fitted to the interior rear view mirror base to detect varying amounts of water on the outside of the windscreen. With Intermittent/Automatic selected, the vehicle will adjust the wiping speed according to the signals provided by rain sensor. Turn the switch (5) to adjust the sensitivity of rain sensor. As the sensitivity increases, the wiping interval decreases.

**Note:** *Immediately operating the wiper one time can be achieved by increasing the sensitivity of rain sensor. If the rain sensor detects continuous rainwater, the wiper will keep working. When no rain is detected, it is recommended to switch off automatic wipe.*

# INSTRUMENTS AND CONTROLS

---

## Slow Wipe

By pushing the lever up to the slow speed wiping position (2), the wipers will operate slowly

## Fast Wipe

By pushing the lever up to the fast speed wiping position (3), the wipers will operate at fast speed.

## Single Wipe

Pressing the lever (4) down and releasing will operate a single wipe, if the lever is held down, the wipers will operate at high speed until the lever is released.

### IMPORTANT

- Avoid operating the wipers on a dry windscreen.
- In freezing or extremely hot conditions, make sure that the wiper blades are not frozen or adhered to the windscreen.
- In winter, remove snow or ice from around the arms and blades, including the wiped area of the screen before use.

## Programmed Wipe

Pull the stalk switch toward the steering wheel (6), the windscreen washers will operate immediately. After a short delay, the wipers will commence operating in conjunction with the washers.

**Note:** *The wipers continue operating for a further three wipes after the stalk switch is released. After several seconds, there will be a further wipe to remove any washer fluid from the screen.*

### IMPORTANT

If the washers fail to deliver the windscreen washer fluid, release the stalk switch immediately. This will prevent the wipers from operating, and the consequent risk of visibility being impaired by dirt smearing across the unwashed windscreen.

## Rear Windscreen Wiper Operation

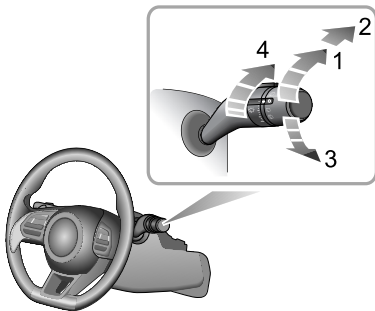

The rear wiper and washer will only operate when the START/STOP Switch is in the ON/READY position. Rotate the rear window wiper switch to your desired selection:

- Intermittent wiping (1)
- Wipe and wash (2)
- Wipe and wash (3)
- Wiper interval adjustment (4)

## Intermittent wipe

Rotate the rear window wiper switch to intermittent wipe (1), the rear window wiper will operate, after several consecutive wipes, the wipers will enter into intermittent mode. The time period between the wipes can be increased/decreased via the intermittent wipe frequency adjustment switch (4).

## Wash and wipe

Turn the rear window wiper switch to the wash and wipe (2) position and hold, the rear window wiper and washer will operate, the rear window wiper wipes quickly. release the switch allowing it to return to intermittent wipe (1), the rear window washer will stop operating, and the wiper wipes slowly, change the stalk switch position 4 to adjust the wipe speed. Turn the rear window wiper switch to wash and wipe (3) and hold, the rear window wiper and washer will operate. release the switch allowing it to return to the OFF position, the rear window washer will stop operating, and the rear window wiper wipes for 3 times, after several seconds, the wiper will wipe once more to remove the washer fluid on the rear screen.

## **INSTRUMENTS AND CONTROLS**

---

*Note: When the tail gate is opened, rear wiper operations will be disabled.*

*Note: When the front windscreen wipers are turned on, if the shift control knob is turned to R position, the rear wiper will operate.*



## Steering System

### Adjustment of Steering Column



**DO NOT attempt to adjust the height or angle of the steering column while the car is in motion. This is extremely dangerous.**

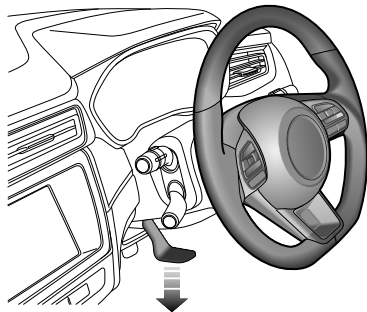

To adjust the angle or height of the steering column to suit your driving posture:

- 1 Fully release the locking lever.
- 2 Hold the steering wheel in both hands and tilt the steering column up or down to move the wheel into the most comfortable position.
- 3 Push or pull the steering wheel towards or away from the body. \*
- 4 Once a comfortable driving position has been selected, pull the locking lever fully up to lock the steering column into its new position.

# INSTRUMENTS AND CONTROLS

---

## Electric Power Steering



***If the electric power steering fails or cannot operate the steering will appear very heavy, this will affect driving safety.***

The electric power steering system only works when the vehicle is in READY mode. The system operates via a motor with assistance levels automatically adjusted based on vehicle speed, steering wheel torque and steering wheel angle.

### IMPORTANT

Holding the steering wheel on full lock for long periods will result in a reduction in power assistance causing a heavier feel to the steering for a short period of time.

## Electric Power Steering (EPS) Warning Lamp

Refer to "Warning Lights and Indicators" in "Instruments and Controls" section.

If the battery has been disconnected for any reason, upon reconnection the warning lamp will illuminate yellow. Movement of the steering wheel from lock to lock will initialise the system and the lamp will extinguish.

## Horn



Press the horn button area (indicated by the arrow) on the steering wheel to operate the horn.

**Note:** *The vehicle horn button and the driver's airbag are located in close proximity on the steering wheel. The illustration shows the position of the horn (indicated by arrow), please ensure that you press*

*in this area to avoid any potential conflict with the operation of the airbag.*

### IMPORTANT

To avoid possible SRS issues, please do not press with excessive force or hit the airbag cover when operating the horn.

# INSTRUMENTS AND CONTROLS

---

## Mirrors

### Door Mirrors

**Note:** *Objects viewed in door mirrors may appear further away than they actually are.*

### Electric Door Mirror Glass Adjustment

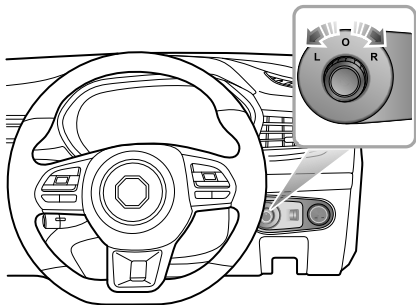

- Rotate the knob to select left (L) or right (R) door mirror.

- Move the knob in the desired direction to adjust the angle of the door mirror glass.
- Upon completion of the adjustment, rotate the knob back to the central position; this will ensure no accidental adjustment of the mirror.

### Heating Elements \*

The door mirrors have integral heating elements which disperse ice or mist from the glass. The heating elements operate while the Heated Rear Window  is switched on.

**Note:** *The heating elements of rear window and door mirror will only work when the power system is in READY mode.*

### Mirror Folding

The mirrors can be folded back towards the side windows into a 'park' position to enable the car to negotiate narrow openings and avoid collisions.

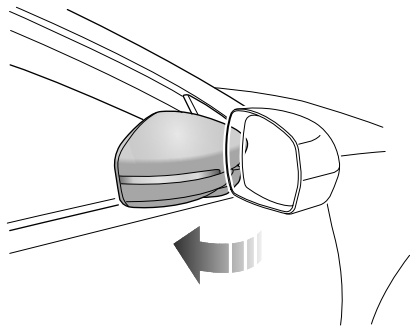

### **Manual Folding of Door Mirror \***

For vehicles not fitted with the electric door mirror fold option, the exterior mirrors can only be folded backwards manually.

### **Electric Folding of Door Mirror \***

For vehicles fitted with electric door mirror folding, rotate the knob to the middle position, and push the knob down. The door mirrors will be folded automatically. Pushing

the knob downwards again will return the mirrors to their original position.

**Note:** *Electrical folding door mirrors that have been moved from their positions by manual or accidental means must be reset by operating the knob to complete fold and deployment one time.*

#### IMPORTANT

- Door mirror glass adjustments are operated by electrical motors. Operating them directly by hand may damage the internal components.
- Washing or flushing door mirrors with high pressure water jets or car washes may result in electrical motor failure.

# INSTRUMENTS AND CONTROLS

---

## Interior Rearview Mirror

Adjust the body of the interior rearview mirror to achieve the best possible view. The anti-dazzle function of the interior rearview mirror helps to reduce glare from the headlamps of following vehicles at night.

### Automatic Anti-dazzle Interior Mirror \*

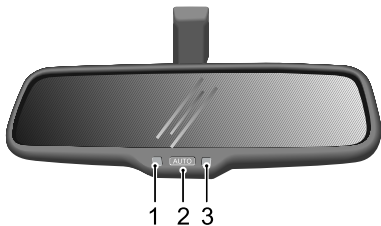

- 1 Operation Indicator                      3 Light Sensor  
2 Automatic Anti-dazzle Function Switch

After the car is placed in READY mode, the automatic anti-dazzle function is switched on automatically (operation indicator ON). If the system detects a following vehicle where the headlamps may dazzle the driver, the light sensor switches on the anti-dazzle function. Press the automatic anti-dazzle function switch (operation indicator OFF) to switch off the automatic anti-dazzle function, and press it again to re-start this function.

The automatic anti-dazzle function may be impaired or limited in the following situations :

- The lights of the following vehicle are not detected by the light sensor.
- Reserve gear is selected.

**Note:** *Attaching film on the rear window may have influences on the usage of automatic anti-dazzle function.*

### Manual Anti-dazzle Interior Rearview Mirror\*

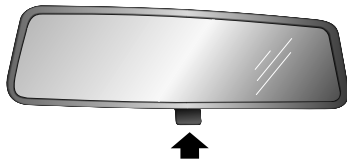

Move the lever at the base of the interior rearview mirror to change its angle, so as to achieve the anti-dazzle function. Normal visibility is restored by pulling the lever back again.

**Note:** *In some circumstances, the view reflected in a 'dipped' manual mirror can confuse the driver as to the precise location of following vehicles.*

# INSTRUMENTS AND CONTROLS

## Sunvisor



**The vanity mirror on the driver side should only be used when the car is stationary.**

Sunvisors (1) are arranged on the roof ahead of both the driver and the front passenger. Some models have vanity mirror (2), depending on the vehicle configuration. For the models which have vanity mirror, pull the sunvisor downward and slide the cover aside to use the vanity mirror.

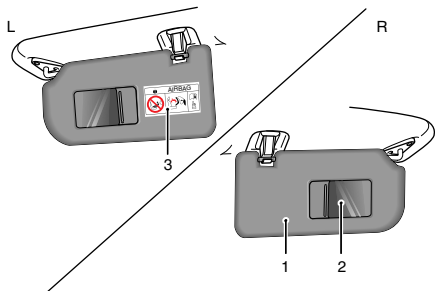

**Note: Warnings and instructions on use of child restraint (3) are attached to both sides of the passenger sunvisor.**

**NEVER use a rearward facing child restraints on a seat protected by an ACTIVE AIRBAG in front of it, DEATH or SERIOUS INJURY to the CHILD can occur. Refer to 'Disabling the Passenger Airbag'.**



## Windows

### Power Operated Window Switch

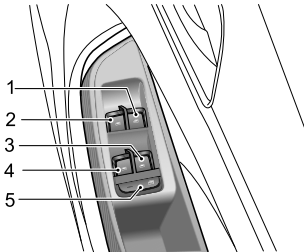

- 1 Front Right Window Switch
- 2 Front Left Window Switch
- 3 Rear Right Window Switch
- 4 Rear Left Window Switch
- 5 Rear Window Isolation Switch

### Window Operation



*Ensure children are kept clear when raising or lowering a window.*



*Improper use or activation of the electric windows by children could cause serious harm or even death. It is the responsibility of the driver and adult passengers to ensure that when carrying children the necessary steps are taken to isolate the window operation. This should include the removal of the key when children are left alone in the vehicle.*

Push the switch (1-4) down to lower, and pull the switch up to raise the window. The window will stop moving as soon as the switch is released (unless the 'One-Touch' function is active).

**Note:** *The front and rear passenger windows can also be operated by individual window switch, mounted on each door. The rear window switches will not operate if the rear window isolation switch has been activated.*

# INSTRUMENTS AND CONTROLS

---

**Note:** *The electric windows can be operated with the vehicle power system in the ACC, ON and READY positions. (For safety: doors should be closed).*

## Rear Window Isolation Switch

Press the button (5) to isolate the rear window controls, press again to restore control.

**Note:** *It is recommended that you ISOLATE the rear window switches when carrying a child.*

## “One-Touch” Down

The window control switch (1-4) has 2 positions. Short press the window control switch to the "2" position and release. The window automatically descends to fully open. Window movement can be stopped at desired position at any time by operating the corresponding switch during descent.

## “One Touch” Up with “Anti-Trap”

Depending on vehicle specification, some windows may have the "One Touch" up function. Lifting the switch to the

"2" position for a short time and releasing will automatically close the window completely. Window movement can be stopped at a desired position at any time by briefly operating the switch again.

The “Anti-Trap” function is a safety feature which prevents the window from fully closing if an obstruction is sensed - if this happens the window will open slightly to allow the obstruction to be removed.

**Note:** *DO NOT operate the power window controls continuously several times in a short time frame, otherwise the power window controls may be disabled to protect the motor. If this occurs, please wait a few seconds until the motor cools down. In the case of the driver's window with "One Touch and Anti-Trap" please wait 30 seconds prior to operation. In some cases it may take 30 minutes to completely cool down, during which time the negative battery lead should not be disconnected.*

**Note:** *If the battery is disconnected, the “One-Touch” and “Anti-Trap” features will be lost. To restore this*

*feature, fully open and then fully close the window holding the switch for 5 seconds in the closed position.*

### **"Lazy Lock" Function \***

The "Lazy Lock" function can open or close all the windows by using the remote key from outside the vehicle as long as it is within detection range.

Press and hold the remote key unlock button until the windows start to open, release the unlock button, all windows will open fully. With the windows open, press and hold the remote key lock button until the windows start to close, release the lock button, the windows will completely close.

# INSTRUMENTS AND CONTROLS

---

## Interior Light

### Front Interior Lamp

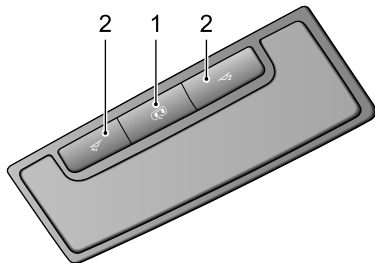

When the automatic operation is enabled, interior lights will illuminate automatically whenever the following occur.

- The car is unlocked.
- Any door is opened.

**Note:** *Under normal circumstances, if a door or the tailgate is left open for longer than 15 minutes, the interior lights will extinguish automatically. In case of low battery, the interior lights will extinguish quicker.*

### Manual Operation

Press one of the switches 2 to turn the corresponding light on, press again to switch off.

### Automatic Operation

Press the switch 1 to select front interior lamp automatic operation, press again to turn off the function.

## Power Socket

### Front Console Power Socket



**Please ensure the socket lid is inserted when the power socket is not in use. This will ensure no debris or foreign objects enter the socket preventing its use or cause short circuits.**

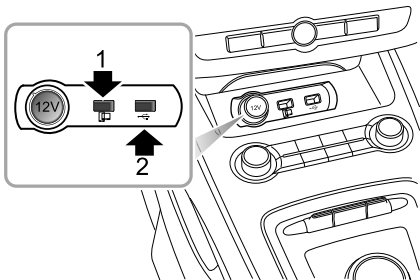

The 12V front console power socket is located in the storage box in front of the shift control knob. When

the START/STOP Switch is in the ACC or ON/READY positions, it can be used as a power supply.

There are 2 USB ports (1 & 2) equipped to the right of the 12V front console power socket. The USB ports can provide a 5V voltage when serving as a power outlet, or realize data transmission. USB port 1 can also provide 'Vehicle-Mobile Phone Interconnection' function.

**Note:** The voltage of the front console power socket is 12 volt, and the power rating is 120 watt. Do Not use electrical equipment with the power exceeding the rating.

**Note:** The USB ports may not support some fast charging devices.

**Note:** Extended use of the accessory power socket and USB socket when the vehicle power system is switched off will cause premature discharging of the vehicle battery.

**Note:** No cigarette lighter is available on the vehicle. If required, please consult an MG Authorised Repairer.

## INSTRUMENTS AND CONTROLS

---

### Rear Console USB Charging Ports \*

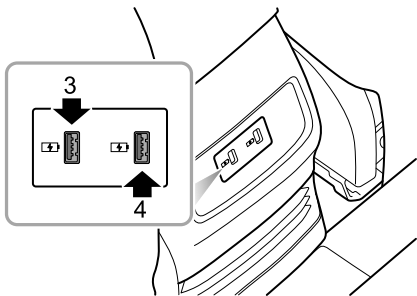

**Note:** Use of the USB port when the vehicle is not in READY mode will consume the battery power, extended use will cause premature discharging of the vehicle battery, and the vehicle may be prevented from being switched into READY mode.

There are 2 USB ports (3 & 4) located on rear console plate, when the START/STOP Switch is in the ACC or ON/READY positions, the USB ports can provide 5V voltage serving as power outlets.

**Note:** The USB ports may not support some fast charging devices.

## Storage Devices

### Instructions

- Please close all storage devices when the car is in motion. Leaving these storage devices open may cause personal injury in cases of a sudden start-off, emergency braking and a car accident.
- Do not place flammable materials such as liquid or lighters in any storage devices. The heat in hot conditions may ignite flammable materials and lead to a fire.

### Glove Box

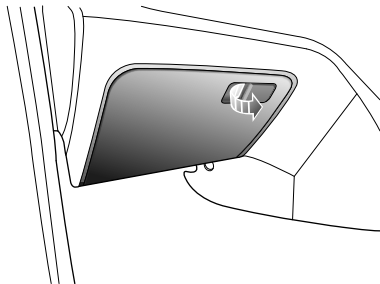

To open the glove box, pull the handle on the glove box cover (as indicated by the arrow).

Push the lid forward to close the glove box. Make sure the glove box is fully closed when the car is being driven.

# INSTRUMENTS AND CONTROLS

---

## Cubby Box

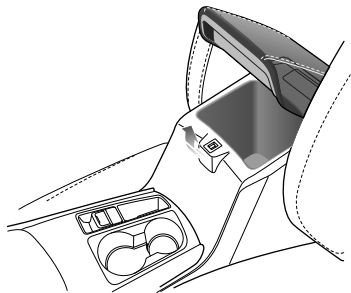

Lift the armrest (arrowed) to open the compartment cover.  
Put the cover down to close it.



## Cup Holder



**DO NOT** place hot drinks in the cup holder whilst driving. Spillage may result in personal injury or damage.

## Centre Console Cup Holder

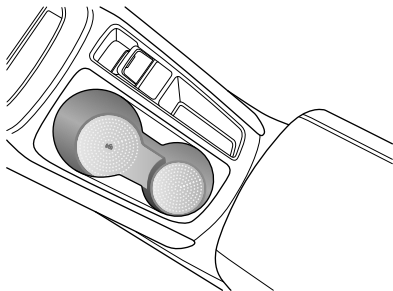

The centre console cup holder is situated at the front end of the centre console armrest assembly.

## Rear Armrest and Rear Cup Holder\*

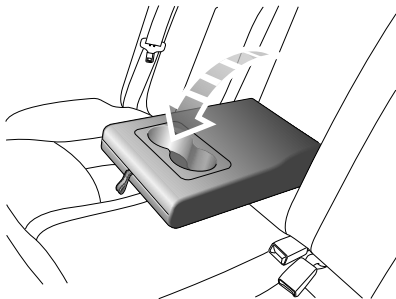

Fold forward to open the rear armrest. There are cup holders at the front end of the rear armrest.

# INSTRUMENTS AND CONTROLS

---

## Roof Luggage Rack \*



**Roof loads *MUST NOT* exceed the maximum authorised load. This may lead to injury or vehicle damage.**



**Loose or improperly fixed loads may fall from the roof luggage rack and lead to an accident or cause injury.**



**When heavy or large items are carried on the roof luggage rack it may lead to changes in steering, handling and braking characteristics. Please avoid sharp maneuvers, heavy braking and excessive acceleration.**

Pay attention to the following when using the roof luggage rack:

- Fix loads towards the front of the roof as far as possible, and distribute the roof load evenly.
- DO NOT use automatic car washes with loads on the roof luggage rack.

- The overall height of the car is different when loads are fitted to the roof luggage rack. Please ensure there is adequate clearance when entering tunnels and garages.
- Ensure the loads carried by the roof luggage rack do not impede operation of the sunroof, roof antenna or tailgate opening.
- When installing or removing a piece of loading equipment, follow the instructions provided by the manufacturer of the loading equipment.

### Maximum Authorised Load for the Roof

The maximum authorised load for the roof is 75 kg, the roof load includes the weight of any roof loads and that of any loading equipment installed.

Ensure you are aware of the weight of loads, and weigh them when necessary. Never exceed the maximum authorised load for the roof.

### Periodical Check

Always check the condition and security of the bolt connectors and fasteners before using the roof luggage rack. Periodically check the condition and security of bolt connectors and fasteners.

## **Air Conditioning**

---

70 *Ventilation*

73 *Electronic Temperature Control* \*

78 *Automatic Temperature Control* \*

# AIR CONDITIONING

---

## Ventilation

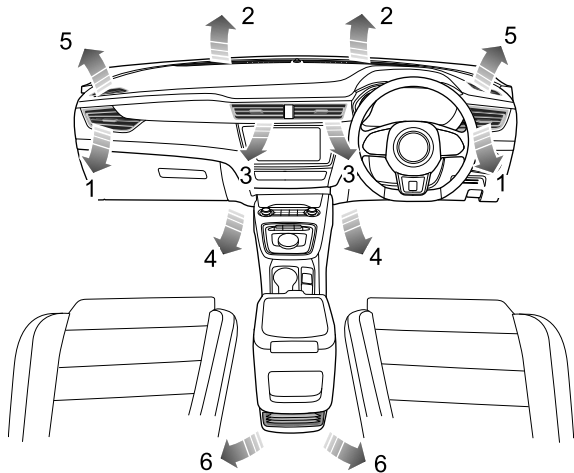

- 1 Side Vents
- 2 Windscreen/Defrost Vents
- 3 Centre Vents
- 4 Front Footwell Vents
- 5 Front Side Window Vents
- 6 Rear Footwell Vents

The heating, ventilation and air conditioning system provides fresh, cooling or heated air to the interior of the car. Fresh air is drawn in through the air intake grille at the base of the front windscreen and particle/pollen filter.

Always keep the air intake grille clear of obstructions such as leaves, snow or ice.

### Particle/Pollen Filter

The particle/pollen filter helps to keep the car interior free from pollen and dust. To remain fully effective, the filter should be replaced at the recommended service interval.

### Vents

#### Centre Vents

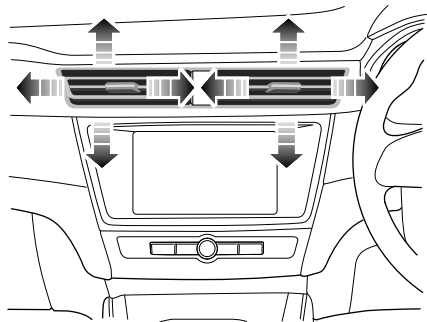

Slide the button in the centre of the louvres completely to the left or right to open or close the vent. Toggle it up and down, left and right to adjust the air direction.

# AIR CONDITIONING

---

## Side Vents

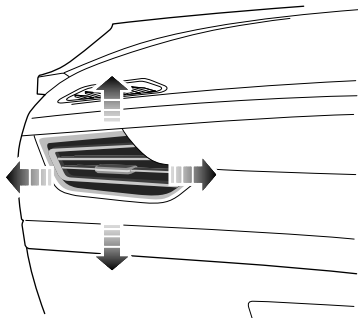

Slide the button in the centre of the louvres completely to the left or right to open or close the vent. Toggle it up and down, left and right to adjust the air direction.

## Electronic Temperature Control \*

### Control Panel

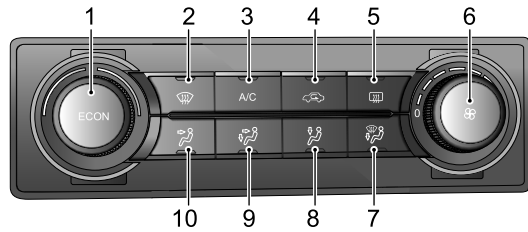



- 1 Temperature Control Knob/Economy Mode Button
- 2 Defrost/Demist Button
- 3 Cooling On/Off Button
- 4 Air Recirculation Mode Button
- 5 Heated Rear Window Button
- 6 Blower Speed Control Knob
- 7 Windscreen and Feet Mode Button
- 8 Feet Mode Button
- 9 Face and Feet Mode Button
- 10 Face Mode Button

# AIR CONDITIONING

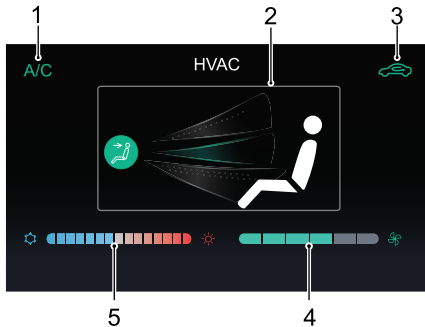
## Interface Display



- 1 Cooling On/Off Display
- 2 Air Distribution Mode Display
- 3 Air Recirculation Mode Display
  - External circulation 
  - Internal recirculation 
- 4 Blower Speed Display

## 5 Temperature Display

### Blower Speed Control

Rotate the blower speed control clockwise to increase the blower speed or rotate anti-clockwise to reduce the blower speed.

**Note:** Select *blower position 0* to switch the air conditioning system OFF. Rotate the *blower speed knob* to *blower speed 1* or above to switch the air conditioning system ON.

### Economy Mode

ECON

Press the ECON button on the control panel, the air conditioning system will enter Economy Mode, the indicator in the button will illuminate. In Economy Mode, the air conditioning system will run at low energy consumption, so as to prolong the driving range.



**Note:**

*Selection of ECON mode will impact situations that require maximum heating or cooling.*

## Cooling On/Off Button



Press to operate; the indicator in the switch will illuminate indicating that the air cooling function is switched on. Press again to switch off.

**Note:**

- 1 *The ventilation and heating function is still available when the air cooling is switched off.*
- 2 *A small amount of water may remain in the air conditioner after usage, this may produce a peculiar smell. If this is a particular issue, it is recommended to switch off the cooling function and run the blower for a while.*

## Temperature Control

Rotate the Temperature Control Knob to adjust the air temperature inside the car.

## Air Distribution Mode

Select the corresponding button to regulate the air distribution mode as required.

Operation Button	Interface display	Air Distribution Mode
		Face Mode
		Face and Feet Mode
		Feet Mode
		Windscreen and Feet Mode

Face Mode : Directs air to the side and centre vents.

Face and Feet Mode : Directs air to side, centre and footwell vents.

# AIR CONDITIONING

---

Feet Mode: Directs air to the footwell vents.

**Note:** *In this mode, a small amount of airflow will be directed to the side, windscreen/defrost and front side window vents.*

Windscreen and Feet Mode: Directs air to the footwell, windscreen/defrost and front side window vents.

**Note:** *In this mode, a small amount of airflow will be directed to the side vents.*

## Defrost/Demist



Press this button on the control panel to operate the defrost/demist function, the indicator will illuminate. The system will automatically set itself to a preset temperature and blower motor speed to effectively clear the side windows and windscreen.

Press again to switch off. Then the indicator will go off, and the system will return to the previous state.

Whilst the defrost/demist is selected, operate the A/C on/off button to turn the compressor on/off; operate

the air recirculation button to switch between internal recirculation and external circulation, operation of either of these functions will not affect the defrost/demist function, operation of any other air distribution modes will quit defrost/demist.

## Heated Rear Window



**The heating elements on the inside of the rear window are easily damaged. DO NOT scrape or scratch the inside of the glass. DO NOT stick labels over the heating elements.**



Press the Heated Rear Window Button to open or close the heated rear window function. The button indicator turns on to open, and turns off to close. The heated rear window function can be automatically closed after running for a certain time.

### Air Recirculation Mode



Press the air recirculation mode button to switch the air recirculation mode to internal recirculation or external circulation. When the indicator illuminates, it is in the internal recirculation mode.

During internal recirculation, the air conditioning system circulates the air inside the car to meet the requirements of rapid cooling or heating, and at the same time, it can prevent the entry of traffic fumes.

During the external circulation, the air conditioning system draws air from outside the vehicle to ensure fresh air enters the vehicle.

**Note:** *Leaving the system in internal recirculation mode can cause the windscreen to mist. If this happens, turn on the defrost/demist mode.*

# AIR CONDITIONING

---

## Automatic Temperature Control \*

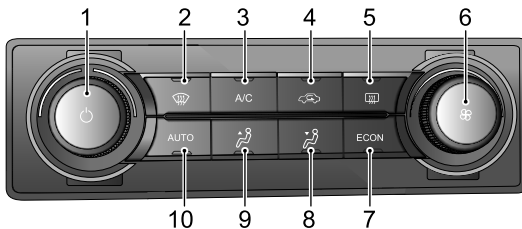

### Control Panel

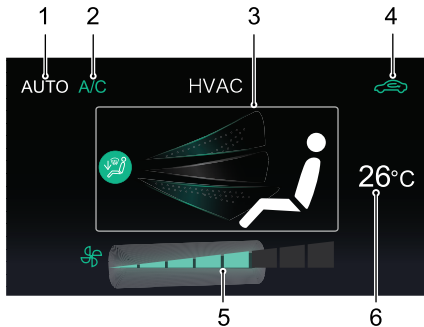

- 1 Temperature Control Knob/System On/Off Button
- 2 Defrost/Demist Button
- 3 Cooling On/Off Button
- 4 Air Recirculation Mode Button
- 5 Heated Rear Window Button
- 6 Blower Speed Control Knob
- 7 Economy Mode Button
- 8 Air Distribution Mode Button 1
- 9 Air Distribution Mode Button 2
- 10 Auto Mode Button

## Interface Display



- 1 Auto Mode Display
- 2 Cooling On/Off Display
- 3 Air Distribution Mode Display
- 4 Air Recirculation Mode Display
  - External circulation 
  - Internal recirculation 

5 Blower Speed Display

6 Temperature Display

## System On/Off



Press the System On/Off Button on the control panel to switch the system on, all functions will revert to the state before shutdown. Press again to switch off.

**Note:** The air conditioning system should only be switched off via the On/Off button.

## Auto Mode



Set the target temperature required and then press the AUTO button to enable the auto mode function. In auto mode, the air distribution mode and the blower speed are automatically adjusted to reach and maintain the required temperature.

**Note:** To ensure the auto mode operates efficiently, all windows and the sunroof must be closed and the air inlet grille must be clear of obstruction. In addition,

# AIR CONDITIONING

---

*the solar sensor on the upper part of the instrument panel should not be covered.*

Manually adjust the air distribution mode or blower speed to exit auto mode. In this case the AUTO indicator will extinguish.

## Economy Mode

A black rectangular button with the word "ECON" in white capital letters.

Press the ECON button on the control panel, the air conditioning system will enter Economy Mode, the indicator in the button will illuminate. In Economy Mode, the air conditioning system will run at low energy consumption, so as to prolong the driving range.

### Note:

***Selection of ECON mode will impact situations that require maximum heating or cooling.***

## Cooling On/Off Button

A black rectangular button with the letters "A/C" in white.

Press to operate; the indicator in the switch will illuminate indicating that the air cooling function is switched on. Press again to switch off.

### Note:

- 1 The ventilation and heating function is still available when the air cooling is switched off.***
- 2 A small amount of water may remain in the air conditioner after usage, this may produce a peculiar smell. If this is a particular issue, it is recommended to switch off the cooling function and run the blower for a while.***



## Temperature Control



Rotate the Temperature Control Knob clockwise to increase the air temperature inside the car or rotate anti-clockwise to decrease.



## Blower Speed Control

Rotate the blower speed control clockwise to increase the blower speed or rotate anti-clockwise to reduce the blower speed.

## Air Distribution Mode

Select  and  to select the air distribution mode as required. You can select face mode, face and feet mode, feet mode, windscreen and feet mode, windscreen Mode.

Interface display	Air Distribution Mode
	Face Mode
	Face and Feet Mode
	Feet Mode

Interface display	Air Distribution Mode
	Windscreen and Feet Mode
	Windscreen Mode

Face Mode : Directs air to the side and centre vents.

Face and Feet Mode : Directs air to side, centre and footwell vents.

Feet Mode: Directs air to the footwell vents.

**Note: In this mode, a small amount of airflow will be directed to the side, windscreen/defrost and front side window vents.**

Windscreen and Feet Mode: Directs air to the footwell, windscreen/defrost and front side window vents.

**Note: In this mode, a small amount of airflow will be directed to the side vents.**

# AIR CONDITIONING

---

Windscreen Mode: Directs air to windscreen/defrost and front side window vents.

**Note:** *In this mode, a small amount of airflow will be directed to the side vents.*

## Defrost/Demist



Press this button on the control panel to operate the defrost/demist function, the indicator will illuminate. The system will automatically set itself to a preset temperature and blower motor speed to effectively clear the side windows and windscreen.

Press again to switch off. Then the indicator will go off, and the system will return to the previous state.

Whilst the defrost/demist is selected, operate the A/C on/off button to turn the compressor on/off; operate the air recirculation button to switch between internal recirculation and external circulation, operation of either of these functions will not affect the defrost/demist function, operation of any other air distribution modes will quit defrost/demist.

## Heated Rear Window



**The heating elements on the inside of the rear window are easily damaged. DO NOT scrape or scratch the inside of the glass. DO NOT stick labels over the heating elements.**



Press the Heated Rear Window Button to open or close the heated rear window function. The button indicator turns on to open, and turns off to close. The heated rear window function can be automatically closed after running for a certain time.

## Air Recirculation Mode



Press the air recirculation mode button to switch the air recirculation mode to internal recirculation or external circulation. When the indicator illuminates, it is in the internal recirculation mode.

During internal recirculation, the air conditioning system circulates the air inside the car to meet the requirements



of rapid cooling or heating, and at the same time, it can prevent the entry of traffic fumes.

During the external circulation, the air conditioning system draws air from outside the vehicle to ensure fresh air enters the vehicle.

**Note:** *Leaving the system in internal recirculation mode can cause the windscreen to mist. If this happens, turn on the defrost/demist mode.*

**Note:** *When switching the system OFF, the vehicle automatically enters internal recirculation mode and the indicator illuminates.*



## **Seats & Restraints**

---

86 Seats

92 Seat Belts

103 Airbag Supplementary Restraint  
System

111 Child Restraints

# SEATS & RESTRAINTS

---

## Seats

### Overview



*To avoid personal injuries due to the loss of control, DO NOT adjust the seats while the car is moving.*

An ideal position of the seat should make sure your driving position is comfortable, which allows you to hold the steering wheel with your arms and legs slightly bent and control all the equipment. Make sure your driving position is comfortable and enables you to maintain full control of the vehicle. Take care when adjusting the height of front seats - the feet of the rear passenger could become trapped when the seat is lowered.

DO NOT recline the front seat backrest excessively. Optimum benefit is obtained from the seat belt with the backrest angle set to approximately 25° from the upright (vertical). The driver and front passenger seats should be positioned as far rearward as practical. A properly adjusted seat helps reduce the risk of injury from sitting too close to an inflating airbag.

## Head Restraints



*Adjust the height of the head restraint so that the top of it is in line with the top of the occupant's head. This location may reduce the risk of head and neck injuries in the event of a collision. DO NOT adjust or remove the head restraints while the car is moving.*



**DO NOT hang anything on any head restraint or head restraint rod.**

The head restraint is designed to prevent rearward movement of the head in the event of a collision or emergency braking, thereby reducing the risk of head and neck injuries.

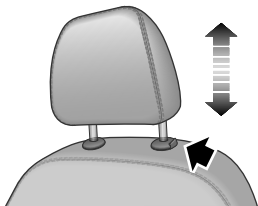

When adjusting a head restraint from low to high position, pull the head restraint directly upward, and gently press it downward after it reaches the desired position to make sure that it is locked in position. To remove the head restraint, press and hold the guide sleeve button (as indicated by the arrow) on the left of the head restraint, then pull the head restraint upward to remove it.

When adjusting a head restraint from high to low position, press the guide sleeve button (as indicated by the arrow) on the left of the head restraint, and press the head restraint downward; release the button after it reaches the desired position, and gently press the head restraint downward to make sure that it is locked in position.

### Front Seats

#### Manual Seat

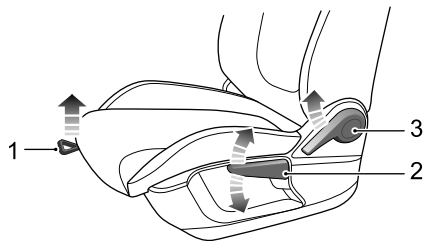

- Forward/Backward Adjustment

Lift the lever (1) under the seat cushion, slide the seat into an appropriate position and release the lever. Make sure that the seat is locked in place.

## SEATS & RESTRAINTS

---

- Cushion Height Adjustment \*

Lift the lever (2) repeatedly to raise the seat cushion, press the lever downward to lower the seat cushion.

- Backrest Adjustment

Lift the lever (3), adjust the backrest until it reaches the desired angle, return the lever to the rest position and ensure the backrest is in a locked position.

### Power Seat \*

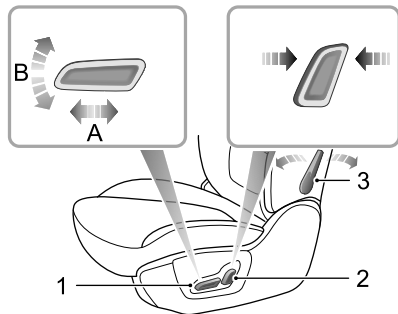

- **Forward/Backward Adjustment**  
Push the switch (1) forward or backward (A) to move the seat forward/backward.
- **Cushion Height Adjustment**  
Pull the switch (1) upward or push downward (B) to raise or lower the seat cushion.
- **Backrest Adjustment**  
Move the switch (2) forward or backward to adjust backrest until it reaches the desired angle.
- **Lumbar Support Adjustment**  
Move the lever (3) to adjust the level of the lumbar support.

### Rear Seats

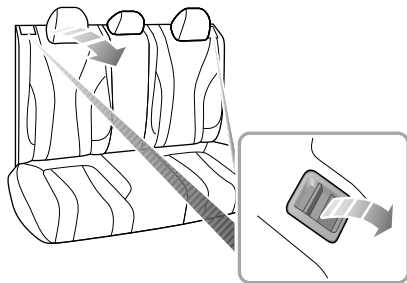

To increase the luggage space, the rear seat backrest can be folded fully forward. When folding the backrest completely, firstly insert the rear seat belt buckle into the corresponding slot, then fully lower (or remove) all head restraints, pull the respective control lever at the top of the seat backrest upwards and fold the seat backrest forward.

## SEATS & RESTRAINTS

---

To return the backrest to an upright position, pull the respective control lever upward to release the lock, raise the backrest to the desired position, a click will be heard when the seat is locked.

**Note:** *When returning the rear seat backrest to the desired position, make sure that the rear seat belt is not trapped.*

**Note:** *If the rear seat head restraints are not fully lowered or the backrest of the front seat is reclined backward excessively, the folding of the rear seat is very likely to damage the back of the front seat, small storage compartment or rear seat head restraint.*

**Note:** *If the rear seat belt buckle is not completely inserted into the corresponding slot, folding the backrest is very likely to damage the rear seat backrest cover or foam.*

### Front Seat Heating \*



***If bare skin is in contact with the heated seats for excessive periods of time, it may cause burns.***

The seat cushion and backrest are provided with heating elements. After the vehicle power mode is set to READY, access the air conditioning control area and press the seat heating switch to enable the heating function of the corresponding seat. Press the switch again to stop the function. When the seat heating function is activated, the operating indicator in the switch illuminates. When the temperature reaches approximate 40°C, the function will be deactivated automatically.



### IMPORTANT

- DO NOT cover the heated seats with blankets, cushions or other insulation type objects or materials.
- If the seat is heated up to 40°C and continues getting hotter when using the seat heating system, please turn off the seat heating and contact an MG Authorised Repairer.
- Overuse of the driver's heated seat may cause drowsiness and could affect safety.

## SEATS & RESTRAINTS

---

### Seat Belts



*It is important that all seat belts are worn correctly. Always check that all passengers are wearing seat belts. DO NOT carry passengers that are unable to wear correctly positioned seat belts. Wearing seat belts incorrectly may cause serious injury or even death in the event of a collision.*



*Airbags can not replace seat belts. Airbags can only provide extra support when triggered, and not all traffic accidents will trigger airbags. Whether airbags are triggered or not, seat belts can reduce the risks of serious injury or death in accidents. Therefore, seat belts must be worn correctly.*



*NEVER unfasten a seat belt whilst driving. Serious injury or death may occur in the case of an accident or emergency braking.*



This vehicle is equipped with seat belt warning lamp to remind you to fasten your seat belt. Please refer to 'Warning Lights and Indicators' in the 'Instruments and Controls' chapter.

During driving, seat belts must be fastened, this is because:

- You can never predict if you will be involved in a collision accident and how serious it may be.
- In many cases of collision accidents, passengers with seat belts correctly fastened are well-protected, while passengers with seat belts not fastened suffer from serious injury or even death.

Therefore, all passengers must wear seat belts correctly, even during short-distance journeys.

### Protection Provided by Seat Belts



*It is of equal importance for passengers in the rear seat to fasten their seat belts correctly. Otherwise, passengers with seat belts not correctly fastened will be thrown forward in accidents, and will endanger themselves as well as the driver and other passengers.*

When the vehicle is in motion, the travelling speed of the occupants is identical to that of the vehicle. In the event of a 'head on collision' or emergency braking, the vehicle may stop, but the occupants will carry on travelling until they come into contact with a stationary object. This object may be the steering wheel, dashboard, windscreen and others.

A correctly fastened seat belt will eliminate this risk of injury. When the seat belt is worn correctly, it will lock automatically in collision accidents or emergency braking to reduce your speed together with the vehicle, so as to prevent the out-of-control movement which may cause serious injury to driver and passengers.



## SEATS & RESTRAINTS

---

### Wearing Seat Belts



*Incorrectly worn seat belts could cause injury or death in the event of an accident.*



*Seat belts are designed for one person. DO NOT share seat belts.*



*DO NOT wrap a seat belt around when holding a baby or child in your arms.*



*Remove any heavy coats or clothing when wearing a seat belt, failure to do so can affect protection provided by the seat belt.*



*Seat belts should not be wrapped around hard or sharp objects such as pens, spectacles or keys.*



*Seat belts cannot function correctly when the seats are reclined excessively. DO NOT drive when the seats are excessively reclined.*

The seat belts fitted to your vehicle are designed for use by normal sized adults. This part of the literature refers to adult use. For advice on seat belt use with children, please see 'Children and Seat Belts'.

All seat belts are 3 point lap-shoulder belts.

In order to maintain effective protection, the passengers must sit in the correct orientation, feet placed on the floor in front of them, with an upright body (no excessive recline) and the seat belt correctly fastened.

### Fastening Seat Belts

Please follow the instructions below to fasten the seat belts correctly.

- 1 Hold the metal tab, pull the seat belt out steadily over the shoulder and across your chest. Ensure the belt is not twisted.

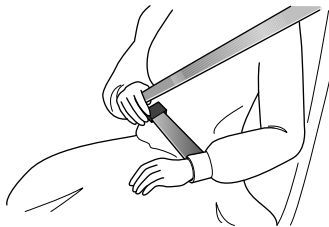

- 2 Insert the metal tab into the buckle until you hear a 'click', this indicates the seat belt is securely locked.

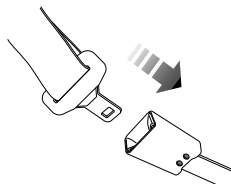

- 3 Remove any slackness in the belt by pulling up on the diagonal section of the belt.
- 4 To release the seat belt, press the red button on the buckle. The seat belt will retract automatically to its original position.

## SEATS & RESTRAINTS

### IMPORTANT

- Always ensure the seat belt will not become trapped in the door aperture when closing the door, damage will occur.
- Pulling the seat belt out too quickly may cause it to 'lock'. In this case, allow the seat belt to retract slightly and then pull it across your body slowly.
- If it is difficult to pull the seat belt out, it may be due to twisted webbing. If this is the case, fully extract the seat belt, remove the twist, allow the seat belt to retract slowly.
- When using the rear seat belts please ensure they are fully retracted into the correct position to avoid jamming in the rear seat catches. It is a legal requirement to wear seat belts. Even if the seat belt is twisted it must be worn. Where possible avoid the twisted section contacting the body and seek advice from an MG Authorised Repairer as soon as possible.

### Correct Routing of the Seat Belts



**Ensure the seat belt is correctly positioned on the body, NEVER cross the neck or abdomen, NEVER pass the seat belt behind the back or under the arms.**

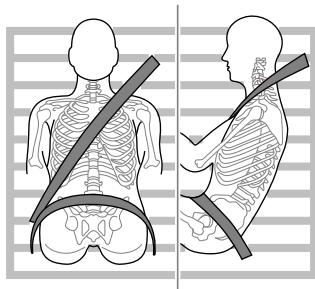

When wearing seat belts, the lap belt section should be positioned as low as possible across your hips. NEVER cross the abdomen. In the event of a collision, the lap belt can apply a force on the hips and reduce the possibility of

you slipping under the lap belt. If you slip under the lap belt, the belt will apply force on your abdomen, which may cause serious or fatal injuries. The diagonal section of the belt should cross the middle of the shoulder and the chest. In the event of emergency braking or collision, the diagonal section of the belt will be locked. NEVER position a seat belt across your neck, across the body under your arms or behind your back.

To ensure that the seat belts always provide maximum protection, ensure the belt is flat, not loose and contacts the body.

### **Seat Belts During Pregnancy**

Wearing correctly positioned seat belts will provide protection for both mother and unborn child in the event of a collision or emergency braking.



The diagonal section of the seat belt should pass across the chest as normal, the lap section of the belt should pass below the belly, low and snug on the hip bones. NEVER position the belt on or above the belly.

Please consult your physician for further details.

### **Seat Belts and Disabilities**

It is a legal requirement that all occupants wear seat belts, this include people with disabilities.

Depending upon the disability, consult your physician for further details.

## SEATS & RESTRAINTS

---

### Children and Seat Belts

**!** *Proper protection measures must be taken for children during driving.*

For safety reasons, children must ride in a child restraint device fixed to the rear seat.

### Infants

**!** *Only recommended child restraints suitable for the age, height and weight of the child should be used.*

**!** *NEVER carry a child or infant with your arms during driving. When collision accidents occur, the weight of child will produce such a great force that you can not hold the child. The child will be thrown forward and suffer serious injury or even death.*

The seat belts fitted to your vehicle are designed for adults, they are not suitable for children. In the event of an accident or collision the children are not secure, it could cause death or serious injury.

Infants **MUST** use a suitable child restraint device. Please consult the child seat manufacturers guide lines when selecting the correct seat. Follow the manufacturers instructions on installation. Please refer to "Child Restraints" in this chapter for more details.

### Older Children

**!** *NEVER share a seat belt amongst children. In the event of an accident or collision the children are not secure, it could cause death or serious injury.*

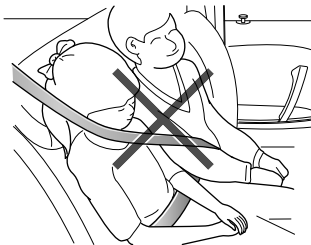



As children grow and become older/larger it will get to the stage when they no longer require child seat restraints, at this point they will require use of the vehicle standard seat belt. Please ensure the seat belt is correctly positioned on the body of the child.

When fastening a seat belt for a child always check it for correct positioning. Adjust the height of seat belt to ensure the shoulder belt is kept away from the child's face and neck. Position the lap belt across the hips as low as possible, and tighten adequately. Correct positioning means that the seat belts can pass the applied force to the strongest part of child's body in accidents.

If the shoulder belt is too close to child's face or neck, it may be necessary to use a child booster cushion (always ensure that it meets any relevant laws or standards.

### Seat Belt Pre-tensioners



*The seat belt pre-tensioners will only be activated once and then **MUST BE REPLACED**. Failure to replace the pre-tensioners will reduce the efficiency of the vehicle's restraint system.*



*If the pre-tensioners have been activated, the seat belts will still function as restraints, and must be worn in the event that the vehicle remains in a drivable condition. The seat belt pre-tensioners should be replaced at the earliest opportunity by an MG Authorised Repairer.*

The vehicle is fitted with seat belt pre-tensioners, these are designed to retract the seat belts and work in conjunction with the airbags in the event of a severe collision. They are designed to retract the seat belt and 'secure' the occupant in the seat.

The airbag warning light on the instrument pack will alert the driver to any malfunction of the seat belt

## SEATS & RESTRAINTS

pre-tensioners.(see 'Warning Lights and Indicators' in the 'Instruments and Controls' chapter).

The seat belt pre-tensioners can only be activated once, after activation they must be replaced. This may also involve replacement of other SRS components. Please refer to 'Replacing Airbag System Parts'.

### IMPORTANT

- Seat belt pre-tensioners will not be activated by minor impacts.
- The removal or replacement of a pre-tensioner must be carried out by the manufacturer trained, dealer technicians.
- 10 years from the initial date of registration (or installation date of a replacement seat belt pre-tensioner), some components will need to be replaced. The appropriate page of the Service Portfolio must be signed and stamped, or the vehicle service records updated once the work has been completed.

## Seat Belt Checks, Maintenance and Replacement

### Seat Belt Checks



*Split, worn or frayed seat belts may not function correctly in the event of a collision, if there are any signs of damage, replace the belt immediately.*



*Always ensure the red release button on the seat belt buckle is pointing upwards to ensure easy release in the event of an emergency.*

Please follow the instructions below to check the seat belt warning lamp, seat belt, metal tab, buckle, retractor and fixing device regularly:

- Insert the seat belt metal tab into the corresponding buckle and pull seat belt webbing close to the buckle quickly to check that the belt clasp locks.
- Hold the metal tab and pull the seat belt forward quickly to check that the seat belt reel locks automatically, preventing the webbing from extending.

- Fully extract the seat belt and visibly examine for twists, fraying, splits or worn areas.
- Fully extract the seat belt and allow to return slowly to ensure continual and complete smooth operation.
- Visibly examine the seat belt for missing or broken components.
- Ensure the seat belt warning system is fully functional.

If the seat belt fails any of the above tests or inspections contact an MG Authorised Repairer immediately for repairs.

### Seat Belt Maintenance



***DO NOT attempt to remove, install, modify, disassemble or dispose of the seat belts. Have any necessary repairs carried out by your MG Authorised Repairer. Inappropriate handling may lead to incorrect operation.***



***Ensure no foreign or sharp objects become lodged in the seat belt mechanisms. DO NOT allow liquids to contaminate the seat belt buckle, this could affect the buckle engagement.***

Seat belts should only be cleaned with warm soapy water. DO NOT use any solvent to clean the seat belt. DO NOT attempt to bleach or dye the seat belt, it may weaken the seat belt. After cleaning, wipe with a cloth and allow to dry. DO NOT allow the seat belt to fully retract before it is completely dry. Keep seat belts clean and dry.

If there are contaminants accumulated in the retractor, the retraction of the seat belt will be slow. Please use a clean and dry cloth to remove any contaminants.

## SEATS & RESTRAINTS

---

### Replacing Seat Belts



*Collision accidents may damage the seat belt system. The seat belt system may not be able to protect users after damage and may cause serious injury or even death when an accident occurs. After the accident, seat belts should be checked immediately and replaced as necessary.*

Seat belts should not require change after minor collisions, however, some other parts of the seat belt system may require attention. Please consult an MG Authorised Repairer for advice.

### Airbag Supplementary Restraint System

#### Overview



*The airbag SRS provides **ADDITIONAL** protection in a severe frontal impact only. It does not replace the need, or requirement to wear a seat belt.*



*The airbags together with the seat belts provide optimum protection for adults, but it is not the case for infants. The seat belt and airbag systems in the vehicle are not designed for protecting infants. The protection required by infants should be provided by child restraints.*

The Airbag Supplementary Restraint System generally consists of:

- Front Airbags (fitted to the centre of the steering wheel and dashboard above the glove compartment)

- Seat Side Airbags (fitted to the outer side of the seat squab)
- Side Head Impact Protection Airbags (fitted behind the headlining)

Please note that this is model and trim level dependant.

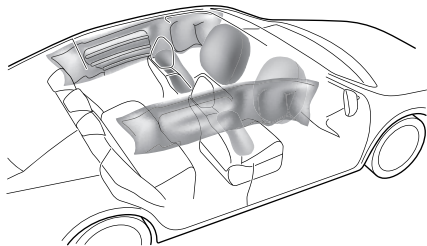

## SEATS & RESTRAINTS

---

In the corresponding position where airbags are fitted, there is a warning sign stating 'AIRBAG'.

### Airbag Warning Light



The airbag warning light is located in the instrument pack. If this lamp does not extinguish or illuminates during driving, it indicates that there is a failure in the SRS or seat belt. Please seek an MG Authorised Repairer at the earliest opportunity. An SRS or seat belt fault may mean the components may not be deployed in the event of an accident.

### Airbag Deployment



*Front seat passengers should not place feet, knees or any other part of the body in contact with, or in close proximity to a front airbag.*



*To minimise the risk of accidental injury from inflating airbags, seat belts should be worn correctly at all times. In addition, both driver and front seat passenger should adjust their seat to provide sufficient distance from the front airbags. If side airbags/side head impact protection airbags are fitted, both driver and front seat passenger should be seated to maintain sufficient distance from the upper part of the body to the sides of the vehicle, this will ensure maximum protection when the side airbags/side head impact protection airbags are deployed.*



**When airbags are deployed, children without proper protection may suffer from serious injury or even death. DO NOT carry children in the arms or on the knees during traveling. Children should wear seat belts suitable to age. DO NOT lean out of windows.**



**An inflating airbag can cause facial abrasions and other injuries if the occupant is too close to the airbag at the time of its deployment.**



**DO NOT affix or place any objects on, or adjacent to the airbags. This may affect the airbag passage or create projectiles that may cause injury or serious harm in the event of airbag deployment.**



**After deployment the airbag components become very hot. DO NOT touch any airbag related components, it may cause burns or serious injury.**



**DO NOT knock or strike the position where airbags or related parts are located, so as to avoid accidental airbag deployment which may cause serious injury or even death.**

In the event of a collision, the airbag control unit monitors the rate of deceleration or acceleration induced by the collision, to determine whether the airbags should be deployed. Airbag deployment is virtually instantaneous and occurs with considerable force, accompanied by a loud noise.

Provided the front seat occupants are correctly seated and with seat belts properly worn, the airbags will provide additional protection to the chest and facial areas in the event of the car receiving a severe frontal impact.

Side airbags and side head impact protection airbags are designed to offer additional protection to the side of the body facing the impact, if a severe side collision occurs.

## SEATS & RESTRAINTS

---

### IMPORTANT

- Airbags can not protect lower body parts of passengers.
- Airbags are not designed for rear collision, minor frontal or side impacts, or if the vehicle overturns; nor will it operate as a result of heavy braking.
- Deployment and retraction of the frontal and side airbags takes place very quickly and will not protect against the effects of secondary impacts that may occur.
- When an airbag inflates, a fine powder is released. This is not an indication of a malfunction, however, the powder may cause irritation to the skin and should be thoroughly flushed from the eyes and any cuts or abrasions of the skin.
- After inflation, front and side airbags deflate immediately. This provides a gradual cushioning effect for the occupant and also ensures that the driver's forward vision is not obscured.

### Front Airbags



***NEVER use a rearward facing child restraint on a seat protected by an ACTIVE AIRBAG in front of it, DEATH or SERIOUS INJURY to the CHILD can occur.***



***Front seat passengers should not place feet, knees or any other part of the body in contact with, or in close proximity to a front airbag.***



***In extreme cases driving on very uneven surfaces may cause airbag deployment. Please take extra care when driving on uneven roads.***

Airbags are designed to deploy during serious impacts, the following conditions may cause airbag deployment.

- A frontal collision with unmovable or non deformable solid objects at a high speed.
- Conditions that can cause serious chassis damage, such as a collision with kerbstones, road edges, deep ravines or holes.



### Seat Side Airbags



*The manufacture and material of the seat is critical to the correct operation of side airbags. Therefore, please DO NOT fit seat covers which may affect side airbag deployment.*

In the event of a serious side impact, the relevant side airbag will deploy (only the affected side).

- The airbag will be deployed in the event that the side of the vehicle is impacted with a solid object or another vehicle.

### Side Head Impact Protection Airbags

In the event of a serious side impact, the relevant side curtain airbag will deploy (only the affected side).

- The side curtain airbag will be deployed in the event that the side of the vehicle is impacted with a solid object or another vehicle.

### Conditions in Which Airbags Will Not Deploy

The deployment of airbags does not depend on the vehicle speed, but on the object that the vehicle hits, angle of impact and the rate at which the car changes speed as a result of a collision. When the impact force of collision is absorbed or dispersed to vehicle body, airbags may not deploy; however, airbags may sometimes deploy according to impact condition. Therefore, the deployment of airbags shall not be judged based on the severity of vehicle damage.

### Front Airbags

Under certain conditions the front airbags may not be deployed. Some examples are listed below:

- The impact point is not central to the front of the vehicle.
- The impact is not of sufficient force (the impact is with an object that is not solid, such as a lamp post or central barriers).
- The impact area is high (collision with the tailgate of a truck).
- Impacts to the rear or side of the vehicle.

## SEATS & RESTRAINTS

---

- The vehicle rolling over.

### Seat Side Airbags and Side Head Impact Protection Airbags

Under certain conditions the seat side and side head airbags may not be deployed. Some examples are listed below:

- Side impacts at certain angles.
- Light side impacts such as a motorcycle.
- Impacts that are not central to the side of the vehicle, either too far toward the front compartment or the loadspace.
- The vehicle rolling over.
- The angled impact is not of sufficient force (the impact is with an object that is not solid, such as a lamp post or central barriers).
- The impact is not of sufficient force (with another vehicle, stationary or moving).
- The impact is from the rear of the vehicle.

### Service and Replacement of Airbags

#### Service Information



***DO NOT install or modify the airbag. Any changes to the vehicle structure or airbag system wiring harness are strictly prohibited.***



***Changes to vehicle structure is prohibited. This may affect the normal operation of the SRS.***



***DO NOT allow SRS areas to be flooded with liquid and DO NOT use petrol, detergent, furniture cream or polishes to clean SRS components..***



***If water contaminates or enters the SRS it may cause damage and affect deployment. In this case contact an MG Authorised Repairer immediately.***

To prevent damage to the airbag SRS, the following areas should be cleaned sparingly with a damp cloth and upholstery cleaner ONLY:

- Steering wheel centre pad.
- Area of dashboard containing the passenger airbag.
- Area of roof lining and front pillar finishers which enclose the side head impact protection modules.

If the airbag warning lamp fails to illuminate, stays on, or if there is damage to the front or side of the vehicle, or the airbag covers show signs of damage, contact an MG Authorised Repairer immediately.

### IMPORTANT

- The removal or replacement of an airbag module should be carried out by an MG Authorised Repairer.
- After 10 years from the initial date of registration (or installation date of a replacement airbag), some components will need to be replaced by an MG Authorised Repairer. The appropriate page of the Service Portfolio must be signed and stamped, or the vehicle service records updated once the work has been completed.

### Replacing Airbag System Parts



***Even if the airbag does not deploy, collisions may cause damage to the SRS in the vehicle. Airbags may not function properly after damage, and cannot protect you and other passengers when a second collision occurs, which may cause serious injury or even death. To ensure that the SRS can function properly after a collision, please go to an MG Authorised Repairer to check airbags and repair as necessary.***

Airbags are designed for using once only. Once the airbag is deployed, you must replace SRS parts.

Please go to an MG Authorised Repairer for replacement.

### Disposal of Airbags

When your vehicle is sold, ensure that the new owner knows the vehicle is equipped with airbags, and is aware of the replacement date of any SRS components.

## **SEATS & RESTRAINTS**

---

If the vehicle is scrapped, the undeployed airbags may have potential risks, therefore, before the disposal, they must be deployed safely in a certain environment by a professional from an MG Authorised Repairer.

### Child Restraints

#### Important Safety Instructions about Using Child Restraints

It is recommended that children below the age of 12 years old should be seated on the rear seat of the vehicle, in a child restraint system appropriate to the children's weight and size. Infants less than 2 years old should be restrained in an infant child restraint system.

It is recommended that a child restraint system that complies with UN ECE-R44 or ECE-R129 standard are fitted in this vehicle. Check markings on the child restraint system.

There are a number of child restraint systems available of different type and specification. For optimum protection, it is recommended that you choose restraint systems appropriate to the child's age and weight.

It is important to comply with installation instructions supplied by the child restraint manufacturer and that the child restraint system is properly secured to the vehicle. Failure to follow these instructions may cause death or

serious injury to the child in an event of a sudden stop or accident.

- All occupants, including children must wear seat belts or use an appropriate child restraint.
- MG strongly recommends that children under 12 years of age or less than 1.5 metres tall should use the appropriate child restraint fitted to the rear seat.
- Only one child can be carried in any one restraint.
- DO NOT put the child on the lap or in arms when sitting in any seat.
- If installing a rear facing child restraint to the rear seat, the corresponding front seat should be adjusted forward; if installing a forward facing child restraint to the rear seat, you may need to adjust the height of the headrest to the lowest; if installing a forward facing child restraint to the front seat, you may need to remove its headrest.
- Never let your child stand or kneel on the seat during driving.
- Always ensure the child is seated correctly in the child restraint.

## SEATS & RESTRAINTS

- The ways of using seat belts have a great influence on the maximum protection offered by the seat belt, you must comply with the child restraint manufacturer's instructions on proper use of seat belts. If seat belts are not properly fastened, a minor traffic accident may also lead to injury.
- Child restraints that are not fitted correctly may move and injure other occupants in the event of an accident or emergency braking. Therefore, even if there is no infant or child in the child restraint, it also should be fitted properly and securely in the vehicle.

### Warnings and Instructions on Use of Child Restraint on Front Passenger Seat



**NEVER use a rearward facing child restraint on a seat protected by an ACTIVE AIRBAG in front of it, DEATH or SERIOUS INJURY to the CHILD can occur.**



**If you choose to install a child restraint on the front passenger seat, move the front passenger seat as far rearward as possible.**



**Use one child restraint per child.**

Please study the safety warning label on the sun visor. Where possible always install child restraints on the rear seat. If it is necessary to install a child restraint on the front seat please observe the warnings above.

### Children's Safety and Side Airbags



**Children should not be allowed in areas where airbags may be deployed, there is a risk of serious injury.**



*Only recommended child restraints suitable for the age, height and weight of the child should be used.*



*DO NOT place any items in areas where airbags may be deployed, there is a risk of serious injury.*

In the event of a side collision, the side airbags can provide better protection for the passenger. However, when the airbag is triggered a very strong expansion force is generated, if the passenger's seating position is not correct, the airbags or items in the side airbag deployment area may cause injury.

When the correct child restraint is used to secure the child properly in the rear seat and the child's seating position is correct, there is enough space between the child and the side airbag deployment region for the airbag to deploy without any hindrance, and thus provide the best protection.

### Child Restraints Groups

#### Secured Using 3 Point lap Diagonal Belts



*Please DO NOT put the rear facing child restraint in the front passenger seat, this may cause serious injury or even death.*

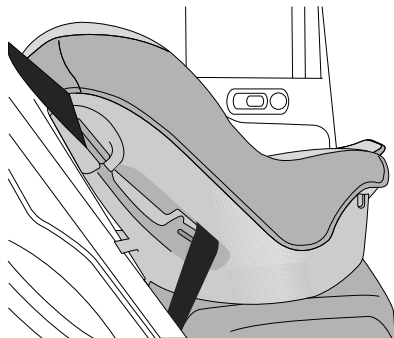

## SEATS & RESTRAINTS

---

It is recommended that children should always be seated in the rear of the vehicle in a child restraint or restraint system, and fixed with 3 point, lap diagonal seat belts.

### ISOFIX Child Restraint Systems



***The ISOFIX anchorages in the rear seat are designed for use with ISOFIX systems only.***



***Child restraint anchorages are designed to withstand only those loads imposed by correctly fitted child restraints. Under no circumstances are they to be used for adult seat belts, harnesses, or for attaching other items or equipment to the vehicle.***

***Note: When installing and using any child restraint system, always follow the manufacturer's instructions.***

***Note: The rear seats fitted to this vehicle are provided with the ISOFIX interface (as indicated by the arrow in the following image), these are designed to connect to an ISOFIX child seat.***

- 1 Fasten vehicle-approved ISOFIX child restraint systems to the mounting brackets.
- 2 When using ISOFIX mounting brackets for seat mounting, universally approved child restraint systems for ISOFIX may be used.



## SEATS & RESTRAINTS



- 3 To fasten the Top tether strap of the child restraint system, route the tether strap under the head restraint and attach to the anchorage hook being careful not to twist the strap. If not using ISOFIX lower anchorages, using the seatbelt, complete the installation in line with the child restraint manufactures instructions.

**Note:** When using seat mounting, universally approved child restraint systems, Top tether must be used.

- 4 After installation apply suitable force to ensure the restraint is securely fastened.

**Note:** Please refer to the child restraint system manufacturer's instructions for details.

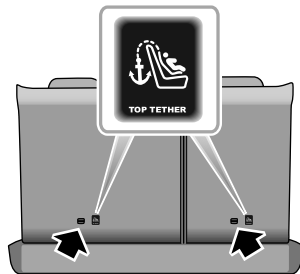

## SEATS & RESTRAINTS

---

### Approved Child Restraint Positions

It is recommended that a child restraint system that complies with UN ECE-R44 or ECE-R129 standard are fitted in this vehicle. Check markings on the child restraint system.

### Approved Child Restraint Positions (for non ISOFIX Child Restraints)

Mass Group	Seating Positions		
	Front Passenger	Rear Outboard	Rear Middle
0 group (less than 10 kg)	X	U	U
0+ group (less than 13 kg)	X	U	U
I group (9 ~ 18 kg)	X	U	U
II group (15 ~ 25 kg)	X	U	U
III group (22 ~ 36 kg)	X	U	U

Note: Description of letters in the table:

U = Suitable for universal child restraint systems approved for this mass group;

X = Seat position not suitable for child restraint systems in this mass group.

## Approved Child Restraint Positions (for ISOFIX Child Restraints)

Seating Position		Mass group categories			
		0 group	0+ group	I group	
		Rear facing		Forward facing	Rear facing
		Up to 29 lbs(13 kg)		20–40 lbs(9 ~ 18 kg)	
Front Passenger Seat	Size Class	Not ISOFIX equipped			
	Seat Type				
Rear Outboard Seat ISOFIX	Size Class	C,D,E <sup>1</sup>	A,B, BI <sup>1</sup>	C,D <sup>1</sup>	
	Seat Type	IL <sup>2</sup>	IL <sup>2</sup> ,IUF <sup>3</sup>	IL <sup>2</sup>	
Rear Centre Seat	Size Class	Not ISOFIX equipped			
	Seat Type				

Note: IL = suitable for particular ISOFIX child restraints of the semi-universal category. Please refer to the vehicle list recommended by child restraints manufacturer;

IUF= suitable for forward-facing ISOFIX child restraints of universal category approved for use in this mass group and ISOFIX size class;

<sup>1</sup> The ISOFIX size class for both universal and semi-universal child restraints is defined by the capital letters grade A to G. These identification letters are displayed on the ISOFIX child restraints;

## SEATS & RESTRAINTS

---

<sup>2</sup> At time of publishing the recommended group 0+ ISOFIX child restraint is the Britax Romer Baby Safe Plus;

<sup>3</sup> At time of publishing the recommended group I ISOFIX child restraint is the Britax Romer Duo Plus.

**Note: At time of publishing the recommended Group II-III ISOFIX child seat is the KidFix XP.**

### Table of I- Size child seats

The table gives a recommendation for which I- Size child seats suit which locations, and for what size of child.

The child seat must be approved in accordance with UN Reg R129.

Type of child seat	Front passenger seat	Rear outboard seats	Rear centre seat
I- Size child restraint systems	X	I-U	X

Note: I-U Suitable for use with forward and rear facing I- Size child restraint systems.

X Not suitable for use with I- Size restraint systems.

### Group 0/0+ Child Restraint



*When the front passenger airbag is active, never place a rear facing child restraint on the front passenger seat, severe injury or even death can occur.*

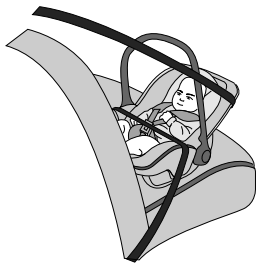

Child restraints that can be adjusted to lying position are most suitable for infants who are lighter than 10 kg (normally for those younger than 9 months) or those who are lighter than 13 kg (normally for those younger than 24 months).

### Group I Child Restraint



*When the front passenger airbag is active, never place a rear facing child restraint on the front passenger seat, severe injury or even death can occur.*



Backward/forward child restraints are most suitable for infants whose weight is 9 ~ 18 kg (normally for those older than 9 months and younger than 4 years old).

## SEATS & RESTRAINTS

---

### Group II Child Restraint



*The diagonal section of the seat belt should pass across the shoulder and upper body, away from the neck. The lap section of the belt should pass across the hips, away from the abdomen.*



The combination of child restraint and 3 point lap diagonal seat belt is most suitable for children whose weight is 15 ~ 25 kg (normally for those older than 3 years old and younger than 7 years old).

### Group III Child Restraint



*The diagonal section of the seat belt should pass across the shoulder and upper body, away from the neck. The lap section of the belt should pass across the hips, away from the abdomen.*



The combination of child booster seat and vehicle 3 point lap diagonal seat belt is most suitable for children whose weight is 22 ~ 36 kg and whose height is below 1.5 m (normally for those about 7 years old or those older than 7 years old).

## Starting & Driving

---

122 Keys

126 Child Proof Locks

127 Anti-theft Systems

134 Starting and Stopping the Power System

138 Pedestrian Alert System

139 Economical and Environmental Driving

141 Vehicle Control

142 Charging Requirements

157 Electric Drive Transmission

167 Brake System

179 Stability Control System (SCS) and Traction Control System (TCS)

180 Tyre Pressure Monitoring System (TPMS)

182 Cruise Control System \*

185 Adaptive Cruise Control System \*

194 Driving Assist System \*

211 Parking Aid

214 Load Carrying

# STARTING & DRIVING

---

## Keys

### Overview



*Please keep the spare key in a safe place - not in the vehicle!*



*Do not hang the spare key on the same key ring, since the electronic interference feature of the built-in safety alarm may cause the key system and alarm control device out of use.*



*The smart key contains delicate circuits and must be protected from impact and water damage, high temperature and humidity, direct sunlight and the effects of solvents, waxes and abrasive cleaners.*

Two smart keys shall be provided. Both of them can operate all locks.

The keys provided to you have been programmed to the security system on your vehicle. Any key that is not programmed to your vehicle cannot start the vehicle.

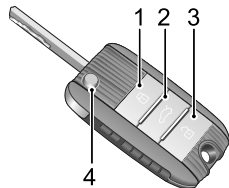

- 1 Lock Button
- 2 Tailgate Release Button
- 3 Unlock Button
- 4 Smart Key

The smart key will only work within a certain range. Its working range is sometimes influenced by the key battery condition, physical and geographical factors. For safety



reasons, after locking the vehicle, check to confirm that the operation was successful.

If your key is lost/stolen or damaged, a replacement can be obtained from a MG Authorised Repairer. The lost/stolen key can be deactivated. If the lost key is found, a MG Authorised Repairer can reactivate it.

**Note:** Any key made independently outside of the MG Authorised Repairer Network may not allow your car to enter READY mode, and may affect the safety of your car. To obtain a suitable key replacement, it is recommended that you can consult MG Authorised Repairer.

**Note:** The new key cannot be offered to you immediately because it requires programming to the vehicle by an MG Authorised Repairer.

**Note:** When operating the vehicle with a smart key, take care not to place the smart key close to devices with strong radio interference (electronic products such as notebook computers, etc.), the normal functions of the key may be affected.

### Replacing the Key Battery

Please use the picture guide to replace the key battery if any of the following conditions occur:

- The effective operating range of the key is significantly reduced;
- The vehicle immobilisation warning lamp on the instrument pack flashes (Refer to "Warning Lights and Indicators" in "Instruments and Controls" section).

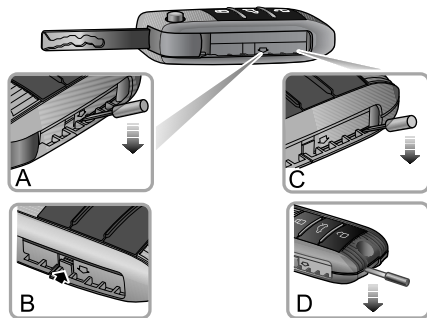

## STARTING & DRIVING

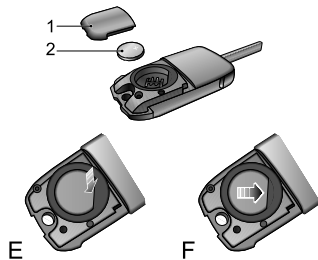

- 1 Unfold the remote key.
- 2 Insert a flat-bladed tool into position (A) shown in the figure, and apply pressure in the direction indicated by the arrow until the clip disengages (B).
- 3 Insert a flat-bladed tool into the position (C), and apply pressure in the direction indicated by the arrow until a gap appears at the tail end of the key.

- 4 Insert a flat-bladed tool into the gap at the tail of the key, as shown in the figure (D), slightly pry the battery cover until the two clips at the tail of battery cover disengage completely.
- 5 Carefully prise off the battery cover. (1).
- 6 Press the front part of button battery using slight force (E) to remove the battery (2).
- 7 Position the new battery, ensuring that correct polarity is maintained (“+” side facing up), slide it forward (F) ensuring it is fully inserted into the slot.

**Note: Make sure that the polarity of battery is correct (positive side upwards).**

**Note: It is recommended to use a CR2032 battery for the remote control.**

- 8 Refit the cover and press tightly. Check the gap around the cover is even.
- 9 Set the vehicle power mode to READY to resynchronize the key with the vehicle.

### IMPORTANT

- Use of an incorrect or inappropriate battery may damage the remote key. The new replacement's rated voltage, sizes and specifications must be the same as the old one.
- Incorrect fitting of the battery may damage the key.
- Disposal of the used battery must be strictly in accordance with relevant environmental protection acts.

## STARTING & DRIVING

---

### Child Proof Locks



**NEVER** leave children unsupervised in the car.

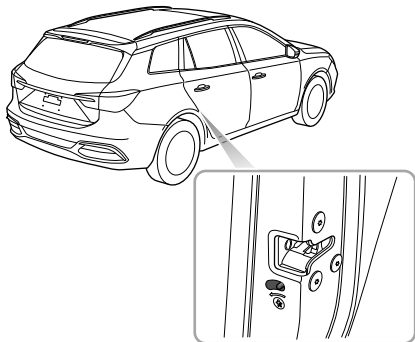

- Open the rear door at corresponding side, move the child proof lock lever to the lock position in the direction of the arrow to engage the child proof lock;
- Move the lever to the unlock position in the reverse direction of the arrow to disable the child proof lock.

With the child proof locks engaged, the rear doors cannot be opened from inside the car, but can be opened from outside the car.

Steps for enabling or disabling the child proof locks are as follows:

### Anti-theft Systems

Your vehicle is fitted with a power immobiliser and a body anti-theft system. To ensure maximum safety and operation convenience, we strongly recommend you read this section carefully to fully understand the activation and deactivation of anti-theft systems.

### Power Immobilisation

Power Immobilisation is designed to safeguard the vehicle from theft. The power immobilisation system can only be deactivated to start the car by using the matched key.

When the START/STOP Switch is pressed and a valid key is detected inside, the immobiliser is deactivated automatically.

If the message centre displays "Smart Key Not Detected" or "Put Key Into Backup Position" or the power immobiliser system warning lamp illuminates, please put the smart key at the backup position (refer to "Alternative Starting Procedure" in "Starting and Stopping the Power System" section), or try to use the spare key. If the vehicle will still

not enter READY mode, please contact an MG Authorised Repairer.

# STARTING & DRIVING

---

## Body Anti-theft System

### Locking and Unlocking

When the vehicle is locked, the indicator lamps flash three times; when it is unlocked, the indicator lamps flash once.

### Key Locking

- Using the remote key to lock: press the lock button on the remote key to lock the vehicle after closing the doors, bonnet and tailgate.
- Using the mechanical key to lock: partially operate the door release handle, using a suitable flat blade tool, insert the tool into the underside of the trim and carefully remove the door lock trim cover, insert the key into the driver door lock and turn counterclockwise to lock the car.

### Key Unlocking

- Using the remote key to unlock: press the unlock button on the key to unlock the car.
- Using the mechanical key to unlock: partially operate the door release handle, using a suitable flat blade tool, insert the tool into the underside of the trim and

carefully remove the driver door lock trim cover, insert the key into the driver door lock and turn clockwise to unlock the car.

**Note:** *If the vehicle power system is not switched to the ACCION/READY position within 15 seconds after the vehicle is unlocked with the mechanical key, the immobilisation alarm will be triggered.*

**Note:** *If no panels are opened within about 30 seconds after the vehicle is unlocked by using the remote key, all doors will automatically re-lock.*

### Operation of Door Lock System (Keyless) \*

The keyless entry system can lock and unlock the doors and tailgate as long as you carry the smart key and approach the car.

IMPORTANT
The smart key must be within 1.5 metres of the vehicle for the keyless system to operate correctly.

### **Keyless Locking**

After switching the vehicle power system to OFF using the START/STOP Switch and exiting the car, press the door handle button once before moving away from the car to lock all doors and tailgate (no need to press the lock button on the key). Note, this will also arm the alarm and immobilise the vehicle.

### **Keyless Unlocking**

Press the button on the front door handle once to unlock the car, then pull the door handle to open the door.

**Note:** *When the vehicle is locked, if you are within the smart key range and operate the door handle button, but carry out no further action, after about 30 seconds the vehicle will automatically re-lock itself to remain secure.*

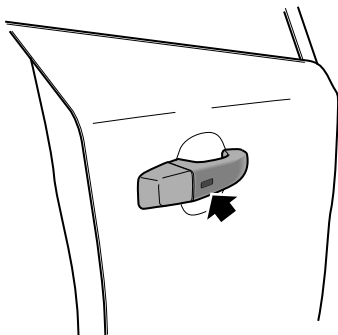

#### IMPORTANT

After the door is locked by using the key, press the button on the door handle to unlock the car. If the car cannot be unlocked or locked normally, seek an MG Authorised Repairer.

# STARTING & DRIVING

---

## Mislock

If the driver's door is not fully closed when the smart key lock button is pressed, or the vehicle power system has not been switched OFF, the vehicle horn will sound once, indicating a mislock. In this case, none of the doors will lock, the alarm system will not be armed and the direction indicator lights will not flash.

If the driver's door is closed, the passenger door, bonnet and tailgate are not fully closed, the horn sounds once to indicate mislock when the car undergoes locking operation. However, the 'partial arming' attributes of the security system will enable as much of the system to be armed as possible (all fully closed doors, bonnet or tailgate apertures will be protected, but an open door will not!). The alarm indicator will flash. As soon as the open aperture is closed, the system will automatically revert to an armed state

## Inadvertent Locking of Keys in Vehicle

If the vehicle is locked using the mechanical key blade or handset whilst a smart key/s remain inside, the following actions will occur:

- One smart key locked in the vehicle - The immobilisation release function of the smart key locked in the vehicle is suspended, the lock and unlock function of the smart key is retained. The vehicle will not change power state. To reinstate the immobiliser release function of the smart key locked in the vehicle the second smart key should be used to unlock the vehicle. The function will automatically be reinstated.
- Both smart keys locked in vehicle - The immobilisation release function of both smart keys locked in the vehicle is suspended, the lock and unlock function of the smart keys is retained. The vehicle will not change power state. The reinstatement of key functions can only be carried out using the approved diagnostic tool. Consult an MG Authorised Repairer immediately.

## Anti-Theft Alarm Sounder

If the anti-theft alarm has been triggered, the car horn will sound continuously. Press the UNLOCK button on the key, the anti-theft alarm will be deactivated.



### Interior Lock and Unlock Switch

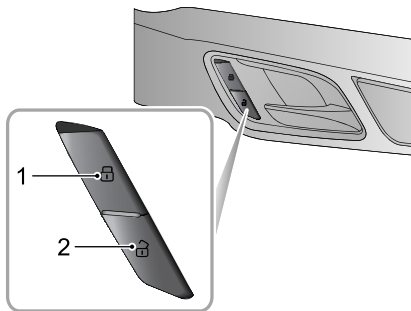

- 1 Lock Switch
- 2 Unlock Switch

When the vehicle anti-theft system is not set, press the lock switch (1) after closing all doors to lock all doors; press the unlock switch (2) to unlock all doors.

**Note:** If the vehicle anti-theft system is set, pressing the lock/unlock switch will not lock/unlock the doors but will trigger the alarm system.

If the doors, bonnet and tailgate are closed, press the interior lock switch, the yellow indicator on the interior lock switch illuminates.

If a mislock is caused by a non-driver door, tailgate or bonnet, press the interior lock switch, the yellow indicator on the interior lock switch illuminates.

# STARTING & DRIVING

---

## Interior Door Handles

Use the interior door handle to open the door:

- 1 Pull the interior door handle once to unlock the door.
- 2 Pull the interior door handle again to open the door.

## Speed Lock

All the doors will be locked automatically when the road speed exceeds 10 mph (15 km/h).

## Automatic Unlock

When the START/STOP is switched to the OFF position, all the doors will be unlocked automatically.

## Tailgate

### Tailgate Open Mode

The manual tailgate can be opened using the following 2 methods:

- 1 Long press the release button on the smart key (B) for more than 2 seconds to unlock the tailgate. Then the tailgate can be lifted open.
- 2 When the vehicle is unlocked, directly press the release switch (A) on the tailgate. Then the tailgate can be lifted open.

**Note:** *On vehicles equipped with keyless entry, if a matched key is detected within a 1m range of the tailgate press the release switch (A) on the tailgate, the tailgate can then be lifted open.*

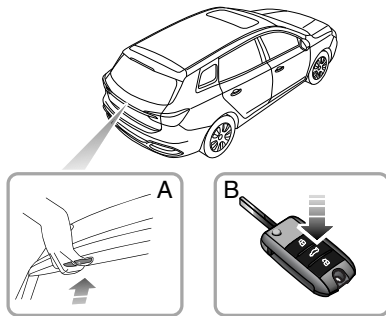

# STARTING & DRIVING

---

## Starting and Stopping the Power System

### START/STOP Switch



The keyless START/STOP Switch is located in the fascia to the right of the steering column, it is a push button style switch. To operate the switch the smart key must be inside the vehicle.

The operational status displays are as follows:

#### **Indicator Off (OFF)**

If the switch has not been operated and there are no indicators illuminated, the power system is OFF. The power electric door mirrors remain operational.

#### **Yellow Light (ACC)**

Pressing the START/STOP Switch without the footbrake being applied whilst the vehicle power system is OFF will place the system in the ACC state, this will illuminate the yellow indicator in the switch button. The ACC position allows operation of certain ancillaries such as power windows.

#### **Green Light (ON/READY)**

- Whilst in the ACC state, pressing the START/STOP Switch without the footbrake being applied will place the system in the ON state, the green indicator will illuminate. This will allow some electrical systems to operate.
- Pressing the START/STOP Switch with P selected and the footbrake applied will place the vehicle in the READY state, the green indicator will illuminate. This indicates that all electrical systems will operate and the vehicle is ready to be driven.

**Note:** *Whilst in the OFF state, if the driver exits the vehicle leaving the smart key inside and closes the driver's door, subsequent re-opening of the driver's door will cause a buzzer to sound and display a warning message in the instrument pack message centre to indicate that the key is still in the car.*

**Note:** *To remove the electronic shift control knob from P the vehicle must be in an ON/READY state and the footbrake applied.*

If your car is subject to strong radio signals the keyless entry and start systems may suffer from interference and not function correctly. Please see the 'Alternative Starting Procedure'.

### READY Mode

#### Setting the power system into READY mode:

- 1 Ensure all unnecessary electrical loads (inc AC) are switched off .
- 2 Ensure the parking brake is applied .
- 3 Ensure P or N is selected (If the shift control knob is in any other position the power system cannot be switched to the ON/READY state).
- 4 Press brake pedal.
- 5 Press the START/STOP Switch (do not hold the button in, release immediately).
- 6 The green indicator will illuminate and READY will be displayed in the instrument pack message centre.

## STARTING & DRIVING

### IMPORTANT

- If the vehicle will not enter a READY state, please check for any warning indicators or messages displayed in the instrument pack message centre. In extremely low temperatures please allow 5 minutes between power up attempts, if after 3 attempts the power state cannot be set to READY please consult an MG Authorised Repairer or breakdown service.
- Do not leave the power system in an ACC or ON/READY state for long periods of time, excessive use of electrical equipment may lead to a discharged battery.
- The vehicle is fitted with an anti-theft system. Independently sourced keys may not allow vehicle entry and system power up. Any new keys will require programming using the manufacturers software.
- Your car is fitted with complex electronic control systems, please ensure that all other radio transmission or electromagnetic devices are kept away from the smart key and centre console cubby areas. They may cause interference and operational issues. Please see the 'Alternative Starting Procedure'.

### Alternative Starting Procedure

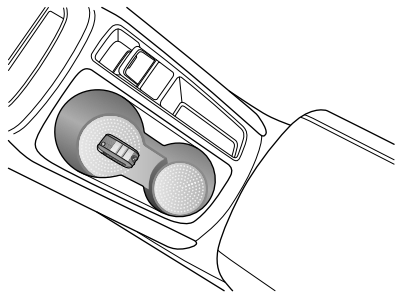

If the vehicle is located in an area where there are strong radio signals causing interference or the smart key battery condition is low, please use the following steps to attempt to start the car:

- I Place the smart key centrally in the centre console cup holder cubby box with the buttons facing upward - as shown in the illustration.

- 2 Ensure P or N is selected, press the brake pedal and then press START/STOP Switch to power the vehicle.

**Note:** *The Alternative Starting Procedure should only be required if the smart key battery is very low or flat. Once the vehicle has been removed from the area of excessive radio interference the keyless entry and START/STOP systems should return to normal.*

### Switching the Power System OFF

Setting the power system to OFF:

- 1 After bringing the car to a halt, ALWAYS maintain brake pedal application.
- 2 Using the electronic shift control knob select (P) and apply the parking brake - please check that the parking brake is applied.
- 3 Press the START/STOP Switch to shut down the power system.

**Note:** *Please observe the park brake warning light and message displayed in the instrument pack*

*message centre confirming that the parking brake is applied before exiting the vehicle.*

# STARTING & DRIVING

---

## Pedestrian Alert System

In order to improve safety, your car is fitted with a Pedestrian Alert System. When the vehicle is travelling at a low speed, the system controls a speaker that sounds to remind pedestrians in the vicinity of your presence.

### Sound Strategies

The speaker sounds when all of the following conditions are met:

- 1 The vehicle is READY;
- 2 The Pedestrian Alert System is fault free;
- 3 During acceleration, the vehicle speed is less than 19 mph (30 km/h); during deceleration, the vehicle speed is less than, or equal to 15 mph (25 km/h).



### Economical and Environmental Driving

#### Running-in

The brakes and tyres need time to 'bed-in' and adjust to the demands of everyday motoring. During the first 900 miles, please avoid heavy braking where possible.

#### Economic Driving and Maintenance

The following are some suggestions on saving power and extending the life of the vehicles.

- Maintain the correct tyre pressure; low pressures will result in accelerated tyre wear and increase power consumption.
- Do not carry unnecessary weight. Heavy loads will increase the vehicle load resulting in higher power consumption.
- Avoid continuous acceleration or deceleration. A stop-go driving style will consume more power.
- Avoid unnecessary stopping and braking, maintain a steady speed and attempt to anticipate traffic lights.

*Note: Keep an appropriate distance from other vehicles to avoid emergency braking and reduce brake pad wear.*

- Avoid traffic congestion and jam areas as much as possible.
- Anticipating obstructions and slowing down well in advance, avoids the need for unnecessary acceleration and harsh braking. A smooth driving style can reduce power consumption.
- Do not ride the brake pedal, this can cause premature wear, overheating and increased power consumption.
- Maintain an appropriate speed on the highway. Higher speeds use more power. Appropriate speed can save power.
- Maintain the correct wheel alignment. Avoid collisions with the kerb and reduce speed on uneven road surfaces. Out of specification wheel alignment will not only lead to excessive tyre wear, but also increases the vehicle load and power consumption.
- Avoid driving on mud or beaches. This will prevent corrosion of the vehicle underside.

## STARTING & DRIVING

---

- Maintain the vehicle in accordance with MG recommendations. .

**Note:** *To extend the life of all components and reduce operating costs, regular MG Approved maintenance is needed.*

- Use of electrical equipment will reduce the power available from the battery. Whilst it is essential to maintain a comfortable interior environment, excessive use of system such as A/C will increase power consumption and reduce the vehicle range.

### Driving in Special Environment

#### Driving in Rain or Snow



**Emergency braking, accelerating and steering on slippery roads will reduce the vehicle's handling performance and grip.**

- When raining the windows may fog, reducing visibility (Use the Air-conditioning demist function).
- Grip will be reduced, so please drive carefully.
- Avoid aquaplaning (the effect of a film of water between the tyres and the road) this will effect steering and braking performance.

#### Driving through Water

Avoid driving through floods after heavy rain, which may lead to serious damage to the vehicle.

## Vehicle Control

### Vehicle Control System

The vehicle control system is used to collect data regarding the requirements from the driver (accelerator pedal, brake pedal, gear shift selection, etc), it uses this information to adjust the driving stability and ride comfort, and to limit the output torque of the vehicle according to the vehicle condition (practical capabilities of current high-voltage battery pack and drive motor).

### Driving Mode

The driver is able to select different driving modes to suit their requirement. In different driving modes, the vehicle control system can use different control strategies for output control. For operation mode, please refer to 'Driving Mode' in 'Electric Drive Transmission' chapter.

### Energy Regeneration

Whilst the vehicle is in an over-run, coasting or braking condition the vehicle will enter the KERS mode, converting part of the kinetic energy into electric energy by driving

the motor, which is then stored in the high-voltage battery pack.

The driver can choose different energy recovery levels as required. For operation mode, please refer to 'Energy Regeneration' in 'Electric Drive Transmission' chapter.

### Power Limit of Electrical Appliances

According to the current load condition and the status of the low-voltage (12V) battery, the vehicle can limit the power of some comfort electrical appliances, such as restricting partial lighting, air conditioning blower. At the same time, the prompt information will be displayed in the information centre in the instrument pack.

#### IMPORTANT

If any of the conditions described above occur, please charge the low voltage battery as soon as possible.

## STARTING & DRIVING

---

### Charging Requirements



*Under normal circumstances it is strongly recommended that you use a slow charging method, avoid constant or regular use of rapid chargers.*



*Prior to using any charging equipment please inspect the sockets, plugs and cables for any damage. DO NOT use any equipment that shows signs of misuse or damage.*



*It is recommended that the charging cable be connected to the charging device before connecting to the vehicle and charging commences.*



*DO NOT attempt to switch the vehicle power system to READY during charging.*



*After charging completion, switch off the charger (where necessary), disconnect the cable from the vehicle, fit the waterproof blanking plugs (2 pin socket cover first), close the charging point door. If necessary you can then disconnect the cable from the charger (where applicable).*



*Whilst charging the car on rainy days, where possible, please avoid connecting the charger during torrential rain or storms. If excessive water is evident around the charging plugs please use a suitable cloth to dry the area as best possible before removing the waterproof blanking plugs and connecting the charging cables.*



*DO NOT touch the charging connector or charging plug when your hand is wet.*



*DO NOT stand in water or snow when connecting or disconnecting the charging cable.*



**DO NOT** attempt to charge when the charging connector and plug are wet.



Always keep the charging connector and charging plug in clean and in a dry condition. Be sure to keep the charging cable in a condition where there is no water or moisture.



Only use the correct charger for charging the electric vehicle. Using any other charger or connector configuration may cause failure.



Take care not to drop the charging connector. This could result in damage.



**STOP** charging immediately if you find anything abnormal, such as sparks, burning or smoke.



Always hold the charging connector handle or plug when connecting or removing the charging cable, if you pull the cable itself (without using the handle), the internal wires may disconnect or get damaged. This may lead to electric shock or fire.



High voltage charging equipment can cause interference with electronic medical devices. When using medical electrical devices such as pacemakers, please consult your doctor about whether charging your electric vehicle will impact the operation of the device. In some instances, electromagnetic waves that are generated from the charger can seriously impact medical electric device operation.



**NEVER** use a high powered jet wash directly on the charger door or to clean around the charge point.

# STARTING & DRIVING

---

## Charging Your Vehicle at Home

Whilst your MG has been supplied with a home charging kit it is essential that you check with a qualified electrician that the infrastructure of your property will support the charging equipment. Please seek qualified advice that your current electrical supply and circuits will support the requirements of the charging equipment.

## Installed Charging Points

Various companies will supply and install charging points to your property, MG insist that only qualified reputable suppliers and installers are used - failure to have the correct equipment installed by a qualified professional may result in overloaded circuits and fire.

## Home Charging Guide

ONLY use certified approved equipment.

ONLY use qualified suppliers and installers.

When the battery is fully charged, disconnect the cable plug from the vehicle socket - if it is necessary to interrupt the charging of the vehicle, disconnect the vehicle plug first, then isolate the power supply.

NEVER allow water or fluids to enter or contaminate your charger or vehicle charging sockets.

NEVER use damaged charging points, equipment or sockets.

STOP charging immediately if you see anything unusual, smell burning or see sparks.

ALWAYS follow the operating instructions supplied with your charging equipment.

**Note: The charging point and power supply infrastructure must be installed and serviced by suitable qualified personnel from an approved installation company using only the materials recommended by them.**

### Charging and Medical Condition Awareness



**High voltage charging equipment can create areas of strong electromagnetic interference, this may cause operational issues with electronic medical devices.**

When using medical electrical devices such as pacemakers or cardioverter defibrillators (ICD's) please consult your doctor about whether charging your electric vehicle will impact on the operation of the device. In some instances, electromagnetic waves that are generated from the charger can seriously impact medical electric device operation.

**Note:** *There are no cautions issued about medical devices when the car is not connected to a charge point and charging. It is perfectly safe for individuals fitted with pacemakers or cardioverter defibrillators to drive or ride in the vehicle.*

### Charging Port

The charging port is located behind the charging port door centrally mounted in the front bumper.

To open the door, ensure the vehicle is unlocked, press the MG badge and release - the door will open to reveal the waterproof plug covers.

Remove the plug covers to reveal the combined charging port.

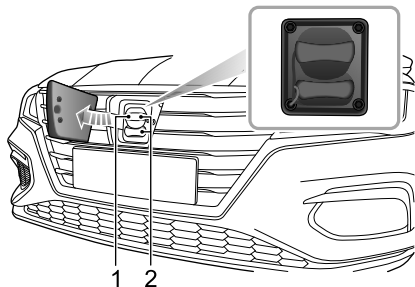

## STARTING & DRIVING

---

- 1 Slow and Fast Charge Port - 7 Pin - Type 2 Plug
- 2 Rapid Charge Port - 7 Pin and 2 Pin - CCS Type Plug

The upper plug covers the 7 pin slow/fast charging socket (1), the lower plug covers the rapid charging socket (2).

**Note: In order to use the rapid charger socket both waterproof plug covers will require removal.**

After charging, refit the waterproof plug covers (2 pin rapid charge socket cover first), close the charging port door and using the MG badge, push the door fully home until the latch locates.

ALWAYS ensure that any excess water is removed from the port area before connecting any charging device.

### Charging Port Electronic Lock

In order to prevent the charging connector and cable being disconnected inadvertently during charging, the charging socket features an electronic locking mechanism.

The electronic lock is activated as soon as the vehicle is locked, and remains in a locked state until the car is unlocked.

Whilst the charging cable is connected and the vehicle locked DO NOT attempt to remove the plug.

Only when the vehicle is unlocked can the charging connector be unplugged.

**Note: The car will not charge whilst in an unlocked state. During charging, if the charging port is unlocked charging will be suspended, it will reinstate when the charging port is locked again. If charging does not automatically recommence please remove and refit the charging cable.**



### Manually Releasing the Charging Port Lock in Emergency Situations

The vehicle features an emergency release device for the charging port lock.

To access the manual release, raise the bonnet and remove the front compartment decorative cover - see picture.

Pull the release cable handle, remove the connector plug whilst maintaining tension on the cable this will release the locking device.

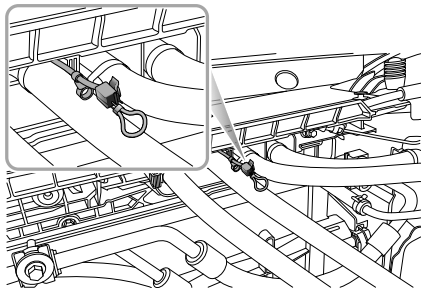

# STARTING & DRIVING

---

## Rapid Charging

**Note:** Please read any equipment operating instructions carefully prior to using the rapid charging station. Each type of charger may use different instructions.

**Note:** The cable of the charging plug should be shorter than 30 m.

If you have any doubts please seek professional assistance.

## Rapid Charging Safety Precautions

- Before connecting the rapid charger, switch the vehicle power system OFF and wait 10 seconds.

**Note:** If at any time during the charging process you should want to check the state of charge, please switch the vehicle power system to the ON position. The high voltage battery state of charge will be displayed in the message centre in the instrument pack.

## Slow Charging

**Note:** Carrying out a full slow charge is the only way for the high voltage battery to reach the optimal equilibrium state (equalisation charge).

High voltage battery chargers are available with various power outputs. Chargers with outputs of up to 3 kW are generally considered as slow chargers, 7 - 22 kW are considered fast chargers and rapid chargers are available in AC or DC outputs. Generally the AC chargers are rated at 43kW and the DC chargers at 50kW plus.

Charging times are dependant on charger output.

To carry out an equalisation slow charge it is recommended that the charger output does not exceed 7kW.

### AC Charging Points

#### IMPORTANT

Please ensure that only charge points that meet IEC 61851 and IEC 62196 are used to connect to your vehicle.

Using an AC charging device:

- 1 Ensure vehicle power system is OFF and all doors are closed.
- 2 Open the charging port door, remove the waterproof plug cover from the 7 pin charging plug connector.
- 3 Plug the cable from the charger point into the vehicle. Lock the vehicle.
- 4 On completion of the charge unlock the vehicle and disconnect the plug from the vehicle.
- 5 Ensure the charge socket is free from debris, fit the waterproof plug cover. Close the charging point door.

**Note:** *If at any time during the charging process you should want to check the state of charge, please switch the vehicle power system to the ON position. the high*

*voltage battery state of charge will be displayed in the message centre in the instrument pack.*

**Note:** *If the vehicle is unlocked during the charging process, charging will be suspended. Charging will resume after 1 minute. If charging does not automatically resume, it may be necessary to remove and refit the charger cable.*

# STARTING & DRIVING

---

## Residential Charging

Your vehicle will have been supplied with a residential charging device. This device can be plugged into a standard household 3 pin socket.

During the charging operation the vehicle power system must be OFF. Carry out the following procedure to charge the car using the charger supplied with the vehicle:

- 1 Ensure vehicle power system is OFF and all doors are closed.
- 2 Open the charging port door, remove the waterproof plug cover from the 7 pin charging plug connector. Ensure the surroundings are clean, dry and free from debris.
- 3 Connect the 7 pin charging plug to the socket on the vehicle.
- 4 Connect the charging device 3 pin plug to the domestic electricity supply. Lock the vehicle.
- 5 On completion of the charge unlock the vehicle, disconnect the charging cable from the vehicle, and then the domestic plug.

- 6 Ensure the charge socket is free from debris, fit the waterproof plug cover. Close the charging point door.

**Note: If at any time during the charging process you should want to check the state of charge, please switch the vehicle power system to the ON position. the high voltage battery state of charge will be displayed in the message centre in the instrument pack.**

**Note: If the vehicle is unlocked during the charging process, charging will be suspended. Charging will resume after 1 minute. If charging does not automatically resume, it may be necessary to remove and refit the charger cable.**

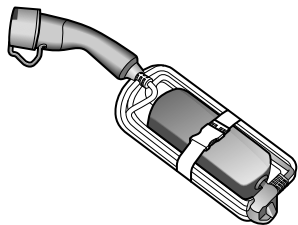

Slow charging kit (supplied with the vehicle)

# STARTING & DRIVING

---

## Charging Information

At the beginning of the charging process, the following information will be displayed within the instrument pack message centre.

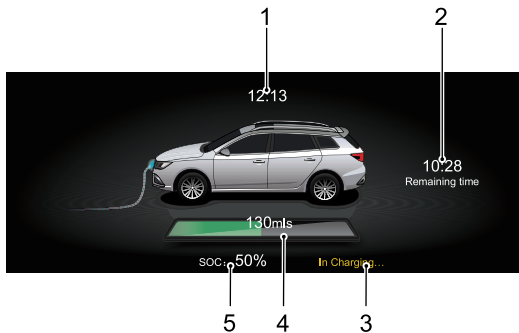

- 1 Current time
- 2 Charging time until full
- 3 Charging status
- 4 Driving range
- 5 High voltage battery pack status

**Note:** The information displayed on the instrument pack may be different based on vehicle configuration.

## Equalisation Charging

Equalisation charging means that after a normal charging process the battery management system will enter a mode where it will attempt to equalise the charge of every battery cell.

If an equalisation charge has not been carried out for some time the message centre in the instrument pack will display 'Please Charge for BMS Balance'. Please refer to 'Slow Charging' in the 'Starting and Driving' section.

On average it takes at least 7.5 hours to complete a charge that includes the equalisation charge.

**Note:** *Ambient temperatures have an effect on charging times, it may take longer to complete a charge when the ambient temperatures are low.*

## Charging Times

Charging times of the high voltage battery can vary depending upon numerous factors, these include: current capacity, charging mode, ambient temperature and device type/power.

### Rapid Charging Time

Rapid chargers will vary in power output, on average it will take approximately 40 - 60 minutes to charge the high voltage battery up to 80% (80% displayed in IPK) using an average rapid charger.

**Note:** *Ambient temperatures have an effect on charging times, it may take longer to complete a charge when the ambient temperatures are low or high.*

### Slow Charging Time

On average it takes approximately 7 hours to charge the high voltage battery from low battery warning to 100% (charge quantity can be checked using the instrument pack).

- At low temperatures the charging time will be extended.

## STARTING & DRIVING

---

- If an equalisation charge has not been conducted for a long time the required charge time will be extended.
- An equalisation charge must be carried out prior to using the car after a long period of storage or non use.

In these cases the charging time will be extended.

***Note: The slow charging notes above relate to using an AC charging device with an output rating of 7kW. Use of the slow charging device supplied with the car using a domestic power supply can increase the charging times by up to 3 times.***



## Indicative Charging Times for Battery Pack Type I

**Note:** *These times are only a guide.*

Rapid charging		From alarm status (the high voltage battery low warning displayed in the instrument pack message centre) to 80%, it takes almost 40 minutes.		
Slow charging	Residential electricity	From alarm status (the high voltage battery low warning displayed in the instrument pack message centre) to 100% (the high voltage battery state of charge displayed in the instrument pack message centre), it takes almost 20 hours.	From alarm status (the high voltage battery low warning displayed in the instrument pack message centre) to 100% (the high voltage battery state of charge displayed in the instrument pack message centre) and equalisation, it takes almost 20.5 hours.	It takes approximately 22 hours to complete an equalisation charge for first use after the vehicle has been parked or stored for a long time.
	AC charging station	From alarm status (the high voltage battery low warning displayed in the instrument pack message centre) to 100% (the high voltage battery state of charge displayed in the instrument pack message centre), it takes almost 7 hours.	From alarm status (the high voltage battery low warning displayed in the instrument pack message centre) to 100% (the high voltage battery state of charge displayed in the instrument pack message centre) and equalisation, it takes almost 7.5 hours.	

# STARTING & DRIVING

## Indicative Charging Times for Battery Pack Type 2

**Note:** *These times are only a guide.*

Rapid charging		From alarm status (the high voltage battery low warning displayed in the instrument pack message centre) to 80%, it takes almost 40 minutes.		
Slow charging	Residential electricity	From alarm status (the high voltage battery low warning displayed in the instrument pack message centre) to 100% (the high voltage battery state of charge displayed in the instrument pack message centre), it takes almost 17 hours.	From alarm status (the high voltage battery low warning displayed in the instrument pack message centre) to 100% (the high voltage battery state of charge displayed in the instrument pack message centre) and equalisation, it takes almost 17.5 hours.	It takes approximately 19.5 hours to complete an equalisation charge for first use after the vehicle has been parked or stored for a long time.
	AC charging station	From alarm status (the high voltage battery low warning displayed in the instrument pack message centre) to 100% (the high voltage battery state of charge displayed in the instrument pack message centre), it takes almost 7 hours.	From alarm status (the high voltage battery low warning displayed in the instrument pack message centre) to 100% (the high voltage battery state of charge displayed in the instrument pack message centre) and equalisation, it takes almost 7.5 hours.	It takes approximately 9.5 hours to complete an equalisation charge for first use after the vehicle has been parked or stored for a long time.

## Electric Drive Transmission

### Instructions

The following information is very important, please read carefully before use:

- The electric drive transmission consists of a high voltage unit. **DO NOT** touch any drive components unless you have the correct training and qualifications.
- Before setting the vehicle power system to ON, please ensure that P or N is selected, the parking brake **AND** footbrake are applied.
- When the vehicle power system is **READY**, use the shift control knob to select your required gear.
- Release the parking brake but maintain footbrake application until you are ready to manoeuvre. On a flat road, once you release the footbrake you will begin to move, slowly apply the accelerator to increase your speed.

### Gear Shift Control

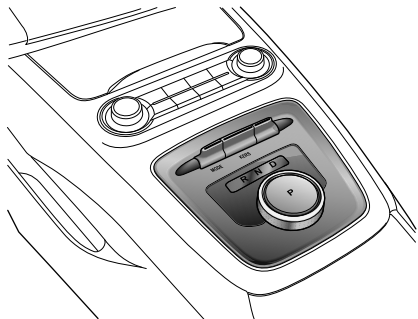

**Note:** The highlighted letters in the information centre indicate the selected gear or mode.

# STARTING & DRIVING

---

## Shift Control Knob Position



**DO NOT** turn the shift control knob to either **P** or **R** from the **D** position whilst driving or whilst the vehicle is in motion. This will cause severe damage to the electric drive transmission or cause an accident.

- P Park

When the shift control knob is in this position, the electronic parking brake is applied. Only select this gear when the vehicle is stationary.

**Note:** The electronic parking brake system must be released via the EPB switch. See “Electronic Parking Brake (EPB)” in the “Brake System” section.

**Note:** When the electronic parking system fails to be activated, the vehicle will enable the parking function of the electric drive transmission, the **P** gear indicator on the shift control knob will flash. Operating the shift control knob to select any other gear will exit Park.

- R Reverse

Select this gear only when the vehicle is stationary and you wish to drive backwards.

- N Neutral

Select this gear when the vehicle is stationary (for example, waiting for traffic lights).

- D Drive

This is used for normal driving.

## Shift Control Knob Operation



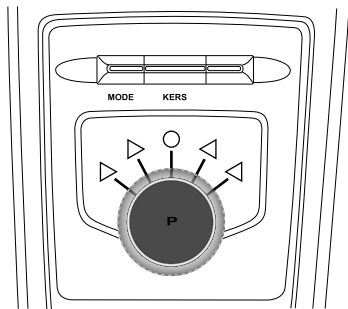

**DO NOT** press the shift control knob whilst driving .



The shift control knob has 5 available positions:

The  position is the default and the only fixed position, any movement of the knob will return to this position.



The  and  positions are sprung loaded momentary positions, after selection the knob will automatically return to the central default position.

In order to prevent accidental operation by pressing the button, the shift control knob requires a firm press to

operate and select P as long as the other specific selection requirements are met.

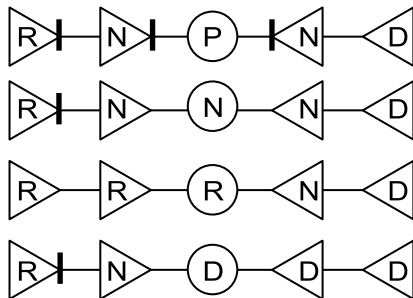
To carry out a gear shift, operate the shift control knob as per the following instructions:



-  Current gear.
-   Unlocked positions.
- | Apply footbrake to allow selection.

# STARTING & DRIVING

---

## Precautions:

- The initial gear position after powering the vehicle will be P. When switching to the R, D or N positions the footbrake **MUST** be applied.
- When switching to the R position from the N position , the footbrake **MUST** be applied.
- If the vehicle speed is below 1 mph (2 km/h), the shift control knob can be pressed to select and engage P.
- If the vehicle speed is below 1 mph (2 km/h) and the START/STOP Switch is operated to power the vehicle OFF, P will automatically be selected and engaged.
- If the vehicle speed is below 1 mph (2 km/h), the footbrake released, the driver seat belt unfastened and the driver door opened, P will automatically be selected and engaged.
- For safety reasons **ALWAYS** apply the footbrake when shifting between R and D positions.

## Vehicle Start-off

The vehicle can only be switched to a **READY** mode with P or N selected and the footbrake applied.

After selecting your desired gear position, after waiting a very short time for the electrical drive transmission to engage and releasing the brake pedal, you should press the accelerator to start driving.

## Driving on Hills



*In cases where a short stop on a hill is required, such as a traffic jam, DO NOT momentarily apply the accelerator to prevent “roll back”. This could cause the electric drive transmission to overheat or even system damage.*

## Hill Start

In cases of a hill start, the start assist function of the electronic parking brake (EPB) can be used to prevent the vehicle from rolling backwards. For details of this function, please refer to “Electronic Parking Brake (EPB)” in “Brake System” section.

Models fitted with Hill Hold Control can use this function to assist hill starts. For details on hill hold control system, please refer to “Hill Hold Control” in “Brake System” section.

**Note:** *The aid of these functions cannot defy the laws of physics. DO NOT drive the vehicle beyond its physical limitations, loss of control will still occur.*

## Driving Mode (MODE)



*Please avoid switching between Driving Modes whilst driving, this may divert the driver's attention away from road conditions and cause an accident.*

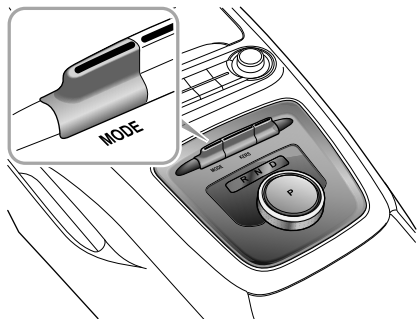

The driver can manually select three driving modes by operating the MODE switch on the centre console: Eco Mode, Normal Mode and Sport Mode.

## STARTING & DRIVING

---

- The message centre in the instrument pack will display: E (Eco Mode), N (Normal Mode), S (Sport Mode).

Toggle the MODE switch forward or backward to switch between the three driving modes.

Every time the vehicle power system is cycled and the system set to READY, the driving mode defaults to Normal Mode.

In each of the different driving modes, the control system uses different control strategies for output control.

### Eco Mode

Economy Mode optimises energy consumption, this will provide the best results regarding the range of the vehicle.

### Normal Mode

Normal Mode combines economy and performance to meet the driving requirements of most drivers.

### Sport Mode

Sport Mode concentrates on providing more power to enhance the performance.

**Note:** *Constant use of Sport Mode will decrease the range of the vehicle.*

**Note:** *It is recommended to choose the Sport Mode when driving on special road conditions such as mountain roads .*

Selecting different driving modes will also automatically select the settings of other systems such as electronic steering and A/C - please see the chart below:

Driving Mode	Power Mode	Steering Mode	A/C Mode	Brake Mode
Eco	Eco	Urban	Eco	Normal
Normal	Normal	Normal	Normal	Normal
Sport	Sport	Dynamic	Sport	Sport

**Note:** *Whilst Eco Mode is selected, the A/C will operate in a low energy consumption state to provide an increase in vehicle power.*



### Energy Regeneration (KERS)



***Deceleration effected by energy regeneration is NOT a substitute for braking safely. The driver must ALWAYS be prepared to make braking manoeuvres to maintain safe driving.***

When the vehicle is in a braking, over-run or coasting state, the energy regeneration function is activated, and the motor converts part of the kinetic energy of the vehicle into electric energy, which is then stored in the high voltage battery.

Energy cannot be regenerated or is limited under some conditions, such as:

- N gear is selected (During driving do not coast in N gear) ;
- During torque intervention (SCS or traction control operation) ;
- High voltage battery is fully charged;
- High voltage battery temperature is too high or too low.

The energy regeneration system (KERS) has three levels:

#### Heavy

Heavy Level: Maximum energy is regenerated, the vehicle exhibits shorter coasting distances and a strong sensation of over-run drag or motor braking. The information centre displays ③ .

#### Moderate

Moderate Level: moderate energy regenerated. The information centre displays ② .

#### Light

Light Level: Minimum energy is regenerated, the vehicle exhibits longer coasting distances and no significant sensation of over-run drag or motor braking. The information centre displays ① .

## STARTING & DRIVING

---

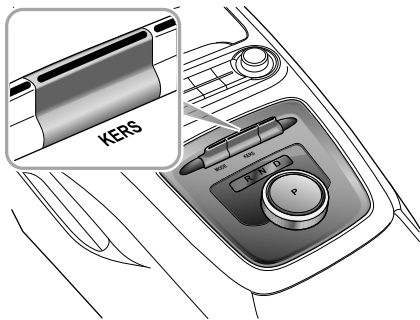

The driver can manually select three energy regeneration levels by operating the KERS switch in the centre console.

Toggle the KERS switch forward or backward to switch between three energy regeneration levels.

Referring to different models:

- 1 On some vehicles, every time the vehicle power system is cycled, and the system then set to READY

mode, the energy regeneration level defaults to the Moderate Level;

- 2 On some vehicles, when the vehicle is powered OFF, the system will return to the last selected regeneration level prior to shutdown when the power system is set to READY mode;



It is recommended to choose Light or Moderate levels on surfaces that have low adhesion levels (e.g. icy roads).

## Protection Mode



*When parking the vehicle, please ensure the vehicle is parked safely and that all traffic by-laws are observed.*

## Motor Overheating Protection of Electric Drive Transmission

The electric drive transmission may become very hot in a high-temperature environment with frequent starting, frequent rapid acceleration and deceleration, long-term continuous steep climbing, and overload of the electric drive transmission. In order to prevent damage to the motor, the system will perform an overheating protection function, the warning indicator  illuminates, and the warning message “Motor Overheating” displays simultaneously. After a few seconds, the warning message will disappear but the warning indicator  will remain on.

In this case, park your vehicle safely or keeping a low load, continue to drive your vehicle at a constant speed to cool the motor. Only when the motor temperature has

decreased, the warning indicator is off, and the warning message disappears, can the vehicle be driven normally.

If the electric drive transmission has cooled down for a long time (about 20 minutes) and the warning indicator has not disappeared, please park the vehicle safely and seek an MG Authorised Repairer immediately, otherwise it may seriously damage the electric drive transmission.

### IMPORTANT

When the motor of the electric drive transmission is under overheating protection, in order to avoid damage to the motor, the power of the vehicle will be limited (the information centre will display “Power Limited, Limiting Speed”, and warning indicator  will illuminate). After decelerating, the warnings will disappear when the motor temperature returns to normal.

## Motor Fault of Electric Drive Transmission



If a fault or failure is detected in the motor or the power electronic box of electric drive transmission, the warning indicator  illuminates, and the warning message

## STARTING & DRIVING



---

“Motor Fault” displays simultaneously. Please seek an MG Authorised Repairer immediately.



### **Parking System Fault of Electric Drive Transmission**

If a fault or failure is detected in the electrical park motor control unit, the warning indicator  illuminates, and the warning message “Parking System Fault” displays simultaneously. After a few seconds, the warning message disappears but the warning indicator  will remain on, please seek an MG Authorised Repairer immediately.

### **Limp Mode**

In some cases, when a fault or failure is detected, the electric drive transmission will enter Limp Mode and will only function at certain speeds, the warning indicator  illuminates, and the warning message “System Fault” displays simultaneously. After a few seconds, the warning message disappears but the warning indicator  will remain on, please seek an MG Authorised Repairer immediately.

### **Severe Functional Malfunction**

In some cases, when a fault or severe failure is detected in the electric drive transmission, the warning indicator  illuminates, and the warning message “System Fault” displays simultaneously. After a few seconds, the warning message disappears but the warning indicator  will remain on. To protect the electric drive transmission, the power system will isolate the power transmission, and the vehicle cannot be driven, please seek an MG Authorised Repairer immediately.

In some cases, when a fault or severe failure is detected in the gear shift system, the information centre will display “EP”. For safety reasons, if the vehicle speed is below a preset speed, the power system will isolate the power transmission, and the vehicle cannot be driven, please seek an MG Authorised Repairer immediately.

## Brake System

### Foot Brake

For added safety, the hydraulic braking system operates through dual circuits. If one circuit should fail, the other will continue to function, but greater pedal pressure will be needed, brake pedal travel will increase, and longer stopping distances will be experienced. In the event of a brake failure where only one circuit is operational, the car should be brought to a halt as soon as traffic conditions safely allow. **DO NOT** continue driving - seek an MG Authorised Repairer.

### Wet Conditions

Driving through water or heavy rain may adversely affect braking efficiency. In this case, keep a safe distance from other vehicles and intermittently apply the brake pedal to keep the brake disc surface dry.

## Electronic Hydraulic Brake Application System (EHBS)

The vehicle is equipped with an electronic hydraulic brake application system; always be aware of the following during the operation:

- The EHBS system functions with the vehicle power system in READY mode only. Never allow the vehicle to freewheel with the power system turned off.
- If the power system should switch off or fail for any reason while driving, bring the car to a halt as quickly as traffic conditions safely allow, and depress the brake pedal with greater force. **DO NOT** continue driving - seek an MG Authorised Repairer immediately.
- If the EHBS system performance degrades due to a low battery or other reasons, you need to apply more force than usual to the brake pedal to stop the vehicle.
- If the EHBS system fails, the instrument pack message centre will illuminate the yellow warning lamp (ⓘ). At this point, the hydraulic booster compensation system starts to provide power assistance, while the power assist performance is relatively low, please slow down

## STARTING & DRIVING

---

to a stop as soon as safety permits and contact an MG Authorised Repairer as soon as possible.

### Braking Response Mode

EHBS provides 2 different braking response modes:

- Standard: provides normal brake boost and brake pedal feel.
- Sport: provides extra brake boost and a more sensitive brake pedal feeling.

The user is able to select the response mode via the drive mode selection function - refer to "Electric Drive Transmission" in the "Starting and Driving" section.

**Note:** *If the driving mode is switched whilst driving, the braking response may not change immediately. After the vehicle comes to a halt and the brake pedal released the mode will switch automatically.*

### Hydraulic Booster Compensation System (HBC)

The vehicle is equipped with an hydraulic booster compensation system. If the EHBS system fails, the HBC system begins to provide power assistance. If any one of

the HBC or EHBS systems fails while the other is capable of providing power assist normally, the instrument pack message centre will illuminate the yellow lamp (ⓘ). At this point, the power assistance performance is relatively low, please slow down to a stop as soon as safety permits and contact an MG Authorised Repairer as soon as possible.

If both the HBC and EHBS systems fail, the instrument pack message centre will illuminate the red lamp (ⓘ). In such a case, please stop the vehicle as soon as safety permits and contact an MG Authorised Repairer as soon as possible.

**Note:** *When the yellow lamp ⓘ in the instrument pack message centre illuminates and the HBC system begins to provide braking assist, a buzzing noise may be heard when pressing the brake pedal, this is normal system operation in these conditions.*

### Cooperative Regenerative Braking System (CRBS)

The vehicle is equipped with a cooperative regenerative braking system, this converts the kinetic energy of the vehicle into electric energy while braking and stores the energy in the HV battery, so as to prolong the driving range.

**Note:** *When the cooperative regenerative braking energy function is triggered, the driver may hear a small motor operational noise and feel a slight vibration on the brake pedal at low road speeds. This is a normal sensation when the system is triggered.*

### **Electronic Brake Force Distribution (EBD)**

The vehicle is equipped with EBD, which, in order to maintain braking efficiency, distributes braking forces between front and rear wheels, under all load conditions.

EBD integrates a monitoring system. The monitoring system is linked to the brake system malfunction indicator lamp on the instrument pack. Refer to "Warning Lights and Indicators" in "Instruments and Controls" section.

If the indicator lamp illuminates while driving, or remains illuminated after the START/STOP Switch is turned on (ON/READY position), it indicates there is a failure with the braking system, and EBD may be inoperative. In such a case, stop the car as soon as safety permits and seek an MG Authorised Repairer immediately. DO NOT drive the car with the brake system malfunction indicator lamp illuminated.

### **Electronic Brake Assistance (EBA)**

The vehicle is equipped with Electronic Brake Assistance (EBA). When the brake pedal is applied for emergency braking, the EBA system will help the driver increase the braking force acted on each wheel to reach the working point of ABS, thereby shortening the braking distance.

# STARTING & DRIVING

---

## Anti-lock Brake System (ABS)



*ABS cannot overcome the physical limitations of stopping the car in too short a distance, running at too high a speed, or in danger of aquaplaning, i.e. where a layer of water prevents adequate contact between the tyres and the road surface.*

The purpose of the anti-lock brake system (ABS) is to prevent the wheels from locking while braking, thereby enabling the driver to retain steering control of the car.

The fact that a car is fitted with ABS must never tempt the driver into taking risks that could affect his/her safety or that of other road users. In all cases, it remains the driver's responsibility to drive within normal safety margins, having due consideration for prevailing weather and traffic conditions.

Under normal braking conditions, ABS will not be activated. However, once the braking force exceeds the available adhesion between the tyres and the road surface, thereby causing the wheels to lock, ABS will automatically

come into operation. This will be recognisable by a rapid pulsation felt through the brake pedal.

## Braking in an Emergency



***DO NOT pump the brake pedal at any time; this will interrupt the operation of ABS and may increase the braking distance.***

If an emergency situation occurs, the driver should apply full braking effort even when the road surface is slippery. ABS will ensure that the wheels do not lock and that the car is brought to a halt in the shortest possible distance for the prevailing road surface conditions.

***Note: On soft surfaces such as powdery snow, sand or gravel, the braking distance produced by the ABS system may be greater than that for a non-ABS system, even improved steering would be experienced. This is because the natural action of locked wheels on soft surfaces is to build up a wedge of material in front of the tyre contact patch. This effect assists the car in stopping.***



No matter how hard you brake, you are still able to continue steering the vehicle as normal.

### IMPORTANT

ABS can not reliably make up for the driver's mis-operation or lack of experience.

### ABS Malfunction Indicator Lamp

Refer to "Warning Lights and Indicators" in "Instruments and Controls" section.

**Note:** *The normal (non-ABS) braking system remains fully operational and is not affected by partial or full loss of ABS. However, the braking distances may increase.*

### Hill Hold Control (HHC)



*HHC has limitations when subject to adverse conditions such as wet or icy surfaces and steep slopes. The driver must always maintain control of the vehicle and attention should not be reduced just because HHC is enabled.*



*HHC is not a substitute for parking brake application when carrying out a hill start. DO NOT exit the vehicle with only HHC applied, it may lead to a serious accident when HHC releases.*



*The car may roll if 'pull-away' is not achieved immediately after releasing the brake pedal. Always ensure the brake pedal is pressed or electronic parking brake applied until drive is taken up.*



*Firm application of the brake pedal when stopping is required by HHC to generate sufficient brake pressure to maintain hold.*

## STARTING & DRIVING

---

Hill Hold Control is a comfort function. It works on inclines when the car detects it has come to a 'stand still status'. It assists the driver by 'holding' the vehicle during hill starts.

The following conditions must be fulfilled to activate HHC:

- The driver's door is closed and the driver seat belt is fastened.
- The vehicle is stopped on a slope in excess of 4%.
- SCS is active and fault free.
- EPB is released and fault free.
- In D or R gear.
- Power system is READY/RUNNING.
- Sufficient brake pedal application force has been applied.

As long as D or R is selected and the brake pedal released, the vehicle will maintain pressure in the braking system for 1 ~ 2 seconds. After this, the Hill Hold will release.

If the driver releases the brake pedal on a hill, HHC will maintain brake pressure for 1 ~ 2 seconds, after this period the vehicle may roll backwards.

**Note: When the HHC system is operating to keep the vehicle still, even if the driver releases the brake**

***pedal, the pedal will not return to its initial position, it will remain in the pressed position. When the brake is released, the brake pedal will return to its initial position.***

**Note: HHC is available in both forward and backward directions when pulling away on uphill slopes.**

**Note: If "Hill Hold Unavailable" is displayed in the information message centre it indicates that the system has detected a fault or another system may be preventing correct operation. Please contact an MG Authorised Repairer as soon as possible.**

### Auto Hold



*When Auto Hold is being used to stabilise the vehicle, power system shutdown, releasing the seat belt or pressing the auto hold switch, the electronic parking brake is applied. It cannot be guaranteed that the vehicle will be stabilised in all cases. For example, the rear wheels are on a slippery road surface, or the vehicle incline is too great (larger than 20%). Please make sure that the vehicle is safely stabilised prior to exiting.*



*DO NOT take any extra risks when driving due to the fact the vehicle is fitted with additional convenience functions. The driver should pay full attention and observe the surroundings even if the vehicle is equipped with the auto hold system.*



*The auto hold function cannot guarantee the stability of the vehicle when starting off or braking on hills especially on slippery or icy surfaces.*



*DO NOT exit the vehicle when the power system is operating and the auto hold is active.*



*Auto hold cannot guarantee the electronic parking brake operation in all cases where the power system is turned off. Please ensure the electronic parking brake is applied and the vehicle is stabilised prior to exiting the vehicle.*



*The auto hold function should be switched off during the use of automatic car washes, the electronic parking brake may suddenly apply and cause vehicle damage.*

With the power system active, if the vehicle is required to stop frequently for a length of time (such as traffic lights, traffic queues or stop/start), the auto hold system assists in stabilising the vehicle, enabling you to remove your foot from the brake pedal when the vehicle is stationary and the Auto Hold active.

Auto hold has 3 main states:

- I Off: Function in Off state.

## STARTING & DRIVING

---

- 2 Standby: Function in Standby state; the function is activated but the vehicle is not parked, and the indicator light of auto hold switch is on. Once the vehicle has stopped, and all other conditions are met, the system will automatically select Park.
- 3 Parking: Function in Parked state. In this state the green lamp (P) in the instrument pack illuminates.

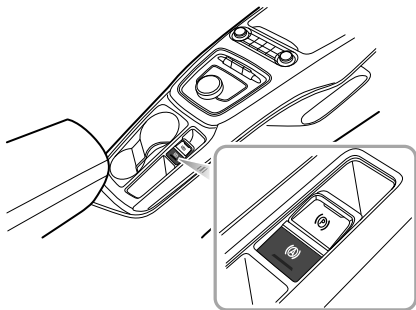

With the driver's seat belt fastened, the door closed and the power system operating, press the auto hold switch to switch the auto hold function from Off to the Standby state.

With the brake pedal firmly pressed and the vehicle completely stopped, the auto hold function will switch from the Standby state to the Parking state.

When the auto hold is in the Parking state, engaging D or R and pressing the accelerator will automatically release the auto hold function.

In some circumstances such as releasing the seat belt, switching off the power system or remaining static for a length of time it will result in the vehicle exiting the auto hold Parking state. At this time the electronic parking brake will remain applied and will require the driver to release it using the switch.

**Note:** When the auto hold is in the parking state, even if the driver releases the brake pedal, the pedal will not return to its initial position, it will remain in the pressed position. When the auto hold automatically releases

or when it is exiting the parking state and enabling the EPB, the brake pedal will return to its initial position.

**Note:** With the brake pedal pressed, operating the switch to turn the auto hold off will NOT apply the parking brake.

**Note:** It is recommended to turn off the auto hold function when reversing into the garage.

### Emergency Braking Hazard Warning Lights Control System (HAZ)

If the vehicle is travelling at high speed and the driver makes an emergency braking manoeuvre, the system will automatically flash the brake lamps to warn the following drivers, thereby effectively reducing the risk of rear-end collision accidents.

**Note:** If the hazard warning lights are being operated manually, this suspends the HAZ function.

When the emergency braking manoeuvre is exited (no severe deceleration detected) then the function will be switched off after a few seconds.

**Note:** As the car speed drops to below 6mph (10km/h) and the system no longer flashes the brake lamps, the hazard warning lamps will illuminate automatically. Short press the hazard warning lamp switch or increase your speed to above 12mph (20km/h) for 5s to switch off the hazard warning lamps.

## STARTING & DRIVING

### Electronic Parking Brake (EPB)



*In the event of EPB malfunction where EPB release is not possible, please consult an MG Authorised Repairer in order to carry out an emergency manual release of the parking brake.*

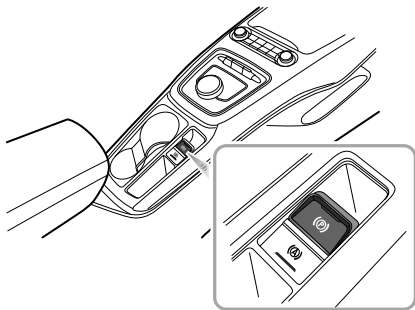

### Applying the EPB

When the vehicle is parked safely, selecting P on the gear shift control knob will automatically apply the EPB. If automatic application of the EPB fails, it is necessary to manually apply the parking brake using the EPB switch

- Pull the EPB switch upward until the indicator in the EPB switch illuminates.
- If the indicator lamp in the EPB switch and the indicator lamp (P) in the instrument pack illuminate, it indicates that the EPB is applied.
- If the EPB MIL (P) in the instrument pack stays on, it indicates that the EPB has a fault. Please contact an MG Authorised Repairer immediately.

**Note:** *An audible motor noise may be heard when applying or releasing the EPB.*

### IMPORTANT

- DO NOT leave the vehicle before the indicator in EPB switch illuminates and the gear indicator displays P, the vehicle may not be safely parked due to EPB failure and slip.
- In the event of a flat battery or power failure it is not possible to apply or release the EPB. If using 'jump leads' to temporarily supply power please see 'Emergency Starting' in the Emergency Information.

### Releasing the EPB

If the vehicle power system is READY, press the brake pedal and use the shift control system to switch from P to N, D or R, the EPB will automatically released.

If automatic release of the EPB fails, it is necessary to manually release the EPB as follows or apply the start assist function of the EPB to release the EPB.

- Place the START/STOP Switch in the ON/READY position, press the brake pedal, and press the EPB switch;

- The indicator in the EPB switch and the indicator lamp (P) in the instrument pack are extinguished, the EPB is released.

### Start Assist

The EPB can predict the driver's intention and automatically release the EPB.

If the driver's seat belt is fastened, the power system is READY, D or R gear is selected and the accelerator pedal is pressed in order to pull away, the EPB will automatically release.

### Emergency Braking Function



***Inappropriate use of the EPB can lead to accidents and injuries. DO NOT apply the EPB for vehicle braking during driving, unless in emergency.***



***During emergency braking using the EPB, DO NOT switch off the vehicle power system, this could result in serious injury.***

## STARTING & DRIVING

---

In the event of normal brake failure, emergency braking using the EPB can be initiated by pulling and holding the EPB switch upward.

- Pulling and holding the EPB switch upward can realize emergency braking. During emergency braking using EPB, an audible warning will sound.
- To cancel the emergency braking process, release the EPB switch.



### Stability Control System (SCS) and Traction Control System (TCS)

#### Stability Control System (SCS)

SCS is designed to assist the driver in control of driving direction. The SCS automatically enters Standby mode after the power system is started.

When SCS detects that the vehicle is not moving in the intended direction, it will intervene by applying brake force to selected wheels or through the power management system to prevent sliding and assist in bringing the car back to the right direction.

#### Traction Control System (TCS)

The purpose of TCS is to aid traction and driving stability, thereby helping the driver to maintain control of the car. TCS monitors the driving speed of each wheel individually. If spin is detected on one wheel, the system automatically brakes that wheel, transferring torque to the opposite, non-spinning wheel. If both wheels are spinning, the system will reduce the output torque of the power system in order to regulate wheel rotation until traction is regained.

#### Switching On/Off

SCS and TCS are automatically switched on when the START/STOP Switch placed in the ON/READY position. They can be switched off by using the "Stability Control" switch located within the infotainment system display.

When SCS and TCS are switched off, Stability Control/Traction Control System OFF Warning Lamps in the message centre of instrument pack will illuminate. Refer to "Warning Lights and Indicators" in "Instruments and Controls" section.

**Note:** *Disabling SCS and TCS will not affect the operation of ABS. Always disable SCS and TCS when driving with snow chains fitted.*

#### Stability Control/Traction Control Warning Lamps

Refer to "Warning Lights and Indicators" in "Instruments and Controls" section.

## STARTING & DRIVING

---

### Tyre Pressure Monitoring System (TPMS)



***TPMS cannot replace routine maintenance and check of the tyre condition or pressure.***



***Using equipment that transmits on frequencies similar to that of the TPMS may interfere with the operation of the Tyre Pressure Monitoring System, this may illuminate a warning or register a temporary fault.***

***Note: TPMS only gives the driver a warning when the tyre pressure is low, it will not inflate the tyre.***

TPMS uses pressure sensors built into tyre valves to continuously monitor pressure and transmits signal to ECU inside the vehicle using RF signals. If it deduces that the pressure of that tyre has fallen below the predefined limit of the system, the warning light on the instrument pack will illuminate (always yellow). For more information, please refer to 'Instrument Pack' in 'Instruments and Controls'

section. Check your tyres at the earliest opportunity and reinflate to the correct pressure. Please refer to 'Tyre Pressure (Cold)' in 'Technical Data' section.

### System Malfunction



This system is self-monitoring, if a malfunction is detected, the TPMS warning lamp (yellow) on the instrument pack will flash for 90 seconds first and then remain illuminated.

***Note: When a puncture is detected, the system will require some time to analyse information prior to illuminating the warning lamp.***

Under certain conditions the warning light may illuminate when a fault is not present, these conditions include:

- A non recommended tyre fitted (including spare tyre).
- Rough terrain driving for excessive periods.
- Bending or mountain type terrain driving for excessive periods.
- TPMS will not respond immediately if a tyre 'blows out'.

### TPMS Self-learning

The TPMS system is a 'self learning' system, after resetting tyre pressures it will be necessary to allow the system to go through a self learning process. This is done by driving the car, during this process the system is suspended and the data displayed may not be correct. If sensors or receiver module are replaced the system requires programming, consult an MG Authorised Repairer. If the wheels are swapped or rotated the system requires reprogramming to learn the new transmitter positions, consult an MG Authorised Repairer.

# STARTING & DRIVING

## Cruise Control System \*

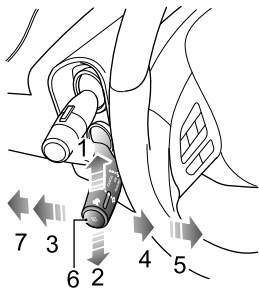

- Acceleration (1)
- Deceleration (2)
- Cancel (3)
- On/Standby (4)
- Resume (5)
- Set (6)
- OFF (7)

Cruise control enables the driver to maintain a constant road speed without using the accelerator pedal. This is particularly useful for motorway cruising, or for any

journey where a constant speed can be maintained for a lengthy period.

### Cruise Control System Activation

Cruise control system is operated with a lever located at the left side of the steering wheel underneath the lighting stalk switch.

- 1 With the START/STOP Switch in the ON/READY position, press lever switch to the 'ON' position (4), the system is in standby, the yellow indicator lamp in the instrument pack illuminates.
- 2 With the system in 'Standby', when the current vehicle speed is above 20 mph (30 km/h), press the 'Set' button (6) at the end of the lever switch. The system will enter the activated state and the indicator lamp in the instrument pack will change from yellow to green. The target speed of the cruise system will be set at the current speed, and the cruise system will take effect. At this time, the cruise control system will maintain the set speed without pressing the accelerator pedal. The operating range of the cruise control system is 20 - 100 mph (30 - 160 km/h).

**Note:** *The set speed held in the cruise control memory will be cancelled when either the cruise control lever is switched to 'OFF' position (7) or the START/STOP Switch turned off.*

### Target Cruise Speed Adjustment

When the cruise control is active:

Push the lever upwards (1) and hold, this will increase the speed. Release the lever switch when the desired speed is reached.

Push the lever downwards (2) and hold, this will decrease the speed. Release the lever switch when the desired speed is reached.

Push the lever switch upwards (1) or downwards (2) briefly to increase or decrease the vehicle target speed in increments of 1 mph (1 km/h), the vehicle will accelerate/decelerate to the new target speed.

Pressing the accelerator at any time will override the cruise control and allow acceleration to undertake manoeuvres such as overtaking. Releasing the accelerator will return the vehicle to the set target speed.

### Pause/Standby

Cruise control will be disengaged and set to 'Standby' if:

- Lever switch moved to 'Cancel' position (3).
- Brake pedal pressed.
- Shift Control Knob moved to P, R or N.
- Conditions initiate SCS intervention.
- An incline causes excessive decline in speed.
- The EPB button is operated.

### Resume

If the cruise control remains on after disengagement, moving the lever switch to the 'Resume' position (5) will reinstate the target speed to the setting prior to disengagement.

### Note:

- **Never use the cruise control system in reverse gear.**
- **DO NOT use the cruise control in unsuitable conditions, such as on slippery surfaces, excessively heavy rain or in traffic conditions that do not suit maintenance of constant speeds.**

## STARTING & DRIVING

---

- *When not in use, ensure the lever switch is in the 'OFF' position (7).*
- *When the electric drive transmission is in 'Sport' mode, it is not recommended to use the cruise control system.*
- *During the operation of the cruise control system, the actual speed may deviate from the target cruise speed to some extent due to road conditions (such as uphill, downhill, etc.).*
- *If the actual speed is excessively lower than the target speed or SCS is activated due to the hill or road surfaces, the cruise control system may automatically revert to Standby mode.*
- *DO NOT operate the switch for excessively long periods, or press multiple switches simultaneously, this may cause the system to fail. If this situation occurs, when it is safe to do so, cycle the vehicle power system.*

### Adaptive Cruise Control System \*



*The adaptive cruise control system is designed as a comfort system enabling the driver to maintain a constant speed or distance from the car in front. It provides assistance to the driver, it DOES NOT replace any of the drivers responsibilities. When using the adaptive cruise control system, it is important that the driver maintains concentration at ALL times and is prepared to take action. Otherwise, accidents or personal injuries may occur.*

The adaptive cruise control system can automatically switch between constant speed cruise and car following cruise depending on whether it can detect a vehicle directly ahead. Constant speed cruise controls the vehicle at a certain speed range. Car following cruise operates by setting the distance between the vehicle and the vehicles directly ahead.

When activated if the adaptive cruise control system detects a vehicle in the same lane directly ahead it may

accelerate or gently apply braking of the vehicle to maintain the set following distance.

**Note:** *The adaptive cruise control system is designed for highways and roads in good condition. It is recommended not to be used on urban and mountain roads.*

**Note:** *Whilst in an adaptive cruise control state the system may be required to apply the brakes, at this time the brake pedal may sink. DO NOT put your foot under or behind the brake pedal, this risks personal injury.*

### Adaptive Cruise Control System Activation



*After following the vehicle ahead to a stop, the driver must observe any local traffic laws and ensure that there are no obstacles or other traffic participants, such as pedestrians, directly in front of the vehicle before allowing it to pull away and begin to follow the vehicle ahead again.*

## STARTING & DRIVING



Whilst using the car following cruise function it is strongly recommended that the driver does not touch the accelerator pedal. Any activation of the accelerator will not allow the system to automatically apply the brakes should this be necessary.



DO NOT exit the vehicle when the adaptive cruise control system car following cruise function has stopped the car, or is keeping the car stationary. Before exiting the car the shift control knob should be in the Park position and the power switch in the OFF position.



If the adaptive cruise control system has already stopped the vehicle, and the adaptive cruise control function is disabled, turned off or cancelled, the vehicle will no longer stay still, it may move forward or slip backward. When the vehicle is stopped and kept still by the adaptive cruise control system, be sure to be ready to apply the brakes manually.



When driving on a bend, the adaptive cruise control may actively reduce the vehicle speed to maintain vehicle stability and safety.

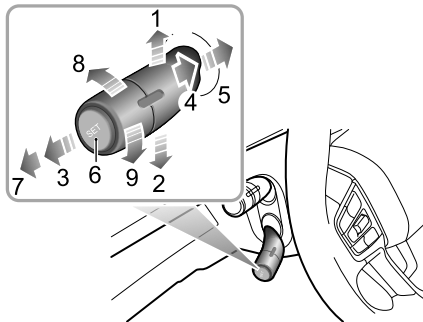

- 1 Speed Limit Increase/Accelerate
- 2 Speed Limit Decrease/Decelerate
- 3 Adaptive Cruise Cancel
- 4 Adaptive Cruise Standby



- 5 Adaptive Cruise Resume
- 6 Adaptive Cruise Set
- 7 Adaptive Cruise OFF
- 8 Increase Distance
- 9 Decrease Distance

The adaptive cruise control system is operated with a lever switch, which is located under the left side of the steering wheel.

- 1 With the vehicle START/STOP Switch in the ON position, if the adaptive cruise lever switch is in the 'OFF' position (7), then the adaptive cruise control system is switched OFF.
- 2 Move the adaptive cruise lever switch to the 'ON' position (4), the adaptive cruise system status indicator on the instrument pack illuminates yellow, and the adaptive cruise control system is in the Standby mode.
- 3 The system will automatically detect the speed and position of the vehicle ahead, if your vehicle speed is above 3 mph (5 km/h), after pressing the 'Set' button (6) at the end of the adaptive cruise stalk lever, the

indicator on the instrument pack will turn green, and the adaptive cruise control system enters the Activated mode, its target speed is the actual speed at activation; if your vehicle speed is less than 20 mph (30 km/h), then the target speed of the system is set at 20 mph (30 km/h). If the speed of the vehicle ahead is greater than the cruise target speed of your vehicle, your vehicle will maintain the target speed to conduct constant speed cruise. If the speed of the vehicle ahead is lower than the cruise target speed of your vehicle, it will enter the car-following cruise. An image of your car and the car ahead is displayed in the instrument pack message centre. In this mode the actual speed may be less than the set target speed. Whilst in the car following cruise mode, you can follow the vehicle ahead to a stop. If the parking time is less than a certain time, your vehicle may automatically pull away to follow the vehicle ahead, or you need re-activate the adaptive cruise control system using the method displayed.

**Note:** *Manual deactivation of either the Traction Control System (TCS) or Stability Control System*

## STARTING & DRIVING

---

*(SCS) will inhibit the operation of the adaptive cruise control system.*

### Adaptive Cruise Target Speed Adjustment

When the adaptive cruise control system is activated:

- 1 Use the accelerator pedal to reach the desired speed, short press the 'Set' button (6) on the end of the adaptive cruise switch lever, release the control button and accelerator pedal. The vehicle will cruise at the desired speed.
- 2 Move the lever switch upward (1) and hold, the target speed will increase until the desired set speed appears in the instrument pack, then release the switch. When it is confirmed that there is no vehicle in front of your vehicle or the vehicle ahead exceeds the preselected following distance, the speed will be increased to the set speed.
- 3 Move the lever switch downward (2) and hold, the target speed will decrease until the desired set speed appears in the instrument pack, then release the switch, the vehicle speed will decrease to the set speed.

- 4 When using the lever to adjust the target speed, briefly operate the adaptive cruise lever switch upward (1) or downward (2) once, the target speed will change 5 mph (5 km/h), press and hold the lever upward or downward and the speed will increase or decrease in 1 mph (1 km/h) increments, release the lever when the desired speed reading is displayed.

**Note:** *If the vehicle ahead continually makes hard acceleration or deceleration manoeuvres the adaptive cruise control may not be able accurately maintain the required distance between vehicles. It is important that the driver always concentrates and pay attention to the current vehicle position and situation in case they need to make a braking or avoidance manoeuvre.*

### Adaptive Cruise Target Following Distance Adjustment

When the adaptive cruise control system is activated, rotate the switch on the end of the lever upward (8) or downward (9) to adjust the following distance, you are able to toggle between 3 distance settings which are displayed in the message centre in the instrument pack.

Always select an appropriate following distance that is relative to the current speed of your vehicle and the vehicle you are following, the greater the speed, the further the distance. ALWAYS consider current traffic, road and weather conditions when making your selection.

### Adaptive Cruise Pause/Standby

When the adaptive cruise control system is activated, move the lever switch to the 'Cancel' position (3), and the system will exit to the Standby mode.

### Automatic Deactivation of Adaptive Cruise

In the following situations, the adaptive cruise control system may be automatically deactivated, this transfers full control of the vehicle to the driver.

- Move the lever switch to 'OFF' position (7).
- Press the brake pedal whilst the vehicle is in motion.
- Move the rotary gear knob to either R or N position.
- The driver unfastens his/her seat belt.
- Press and hold the accelerator pedal beyond a preset time period.
- Open any door, bonnet or tailgate.

- Pull the EPB switch up to apply the parking brake.
- Follow the vehicle ahead to a stop and the stop time exceeds a certain period of time.
- The camera or radar view is blocked, the surrounding environment triggers the preset safe exit mechanism of the sensors, or the system fails.

**Note:** *If following the vehicle ahead to a stop with the adaptive cruise control system enabled, if any of the following conditions occur whilst the vehicle is in a stopped state, the EPB will automatically be applied:*

- *The driver unfastens his/her seat belt.*
- *The driver door is opened.*
- *The stationary time exceeds the preset time period.*

### Adaptive Cruise Override

If the driver has cause to use the accelerator pedal when the adaptive cruise control system is activated, the vehicle will remain in Cruise mode while the vehicle speed increases. When the accelerator pedal is released, the adaptive cruise control system will resume to operate at previously set cruise speed.

# STARTING & DRIVING

---

## Adaptive Cruise Resume

If the adaptive cruise control system has reverted to, or been switched to, the Standby mode it can be reactivated by moving the lever switch to the 'Resume' position (5). The target cruise speed will automatically be set to the target speed before exiting the adaptive cruise control system.

## Clear Speed Memory

If the lever switch is moved to the 'OFF' position (7) or the vehicle START/STOP Switch is switched to the OFF position, the system may clear the adaptive cruise control set speed in the memory.

## Adaptive Cruise Control System Impairment and Ineffectiveness

- Encounters a vehicle or object which is stationary or traversing the lanes.
- Approaching the vehicle ahead too fast, and the system cannot apply sufficient braking force.
- The vehicle ahead is an oncoming vehicle, or makes an emergency braking manoeuvre.
- A vehicle suddenly cuts into the lane in front.
- Encounters a vehicle driving at a low speed.
- Encounters a vehicle with loaded items protruding from the body profile of the vehicle.
- Encounters a vehicle with a higher chassis (e.g., a truck).
- Encounters pedestrians, non-motor vehicles or animals.
- The vehicle is driving on an uneven road or a complex traffic road section.

- The vehicle makes a sharp turn.
- Enters and leaves a tunnel or drives in the tunnel.
- Drives in the shade of mottled trees.
- Excessive weight being carried in the boot space or cargo area causing the front of the car to point upwards.

### Special Driving Environments

The adaptive cruise control system has its limitations. Listed below are some conditions that may be beyond the safe operating limits. The driver should maintain control of the vehicle and must remain alert at all times. They should pay special attention to the traffic conditions and surroundings, select the appropriate speed and be ready to take any required actions.

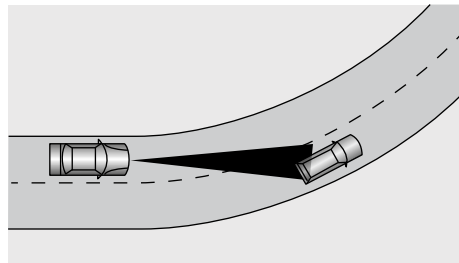
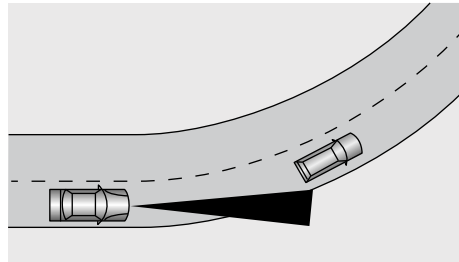

## STARTING & DRIVING

---

When turning at an intersection or following a vehicle into, or out of a curve, the adaptive cruise control system may be unable to detect the vehicle ahead, even if it is in the same lane, it is possible the system may detect a vehicle in another lane.

**Note: Do not use the adaptive cruise control system on entrance/exit ramps or sharp bends.**

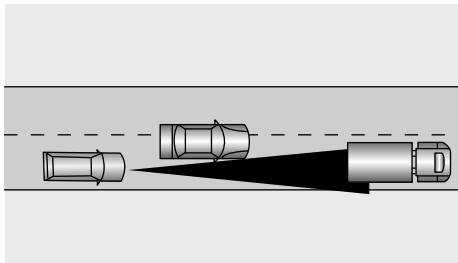

If the vehicle ahead changes lanes, but does not drive into the lane completely, the adaptive cruise control system may be unable to detect the vehicle.

If the vehicle ahead changes lanes, but does not exit the lane completely, the adaptive cruise control system may determine that the vehicle ahead has exited the lane and accelerate to any preset speed.

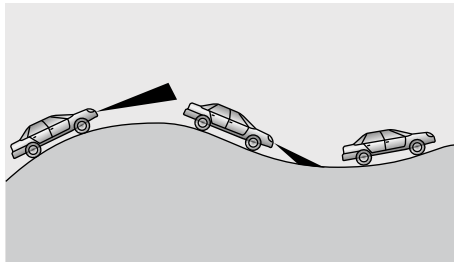

When driving on uneven roads that may include steep climbs or dips please DO NOT use the adaptive cruise control system.

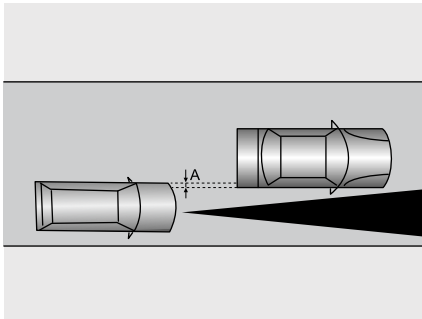

- *Driving on rough or poor road surfaces.*
- *Driving through roadworks or construction sites.*
- *Driving on low friction roads.*

When driving behind a vehicle that is only partially overlapping your vehicle, 'A' in the graphic, the adaptive cruise control system may be unable to detect anything.

**Note:** Please **DO NOT** use the adaptive cruise control system in the following situations:

- *Driving in bad weather conditions.*
- *When the ambient light is insufficient, the light is too much, or the front lighting of the vehicle is poor.*

# STARTING & DRIVING

---

## Driving Assist System \*

The driving assist system can detect the road and environmental information ahead of the vehicle by utilising a front view camera and a front detection radar under certain conditions. This information is used to relay warning messages or provide assistance to help the driver control the vehicle more safely and reliably. The front view camera is located in the interior rearview mirror base cover, the front detection radar is located at the lower middle of the front bumper.

**Note:** *DO NOT operate any infotainment switches whilst driving. If you wish to make any settings changes, please pull over when it is safe and legal to do so.*

## Description of Front View Camera

### Calibration of front view camera

The front view camera re-calibration is required after any of the following:

- Removal and refitting of the front view camera.
- Replacement of the windscreen.

**Note:** *The calibration of front view camera requires professional knowledge and tools. If calibration is required, please seek an MG Authorised Repairer.*

### Obstruction of the front view camera

On occasion the front view camera view may become obstructed by foreign objects or stains on the glass. In these cases a prompt message will appear in the information centre. Please wipe or clean immediately.

**In the following situations, the detection performance of front view camera will be affected:**

- Driving in poor weather conditions where visibility is reduced due to thick fog, heavy rain, snow, dust or sand storm etc.
- Affected by light, for example low light levels at night, poor auxiliary lighting, excessive backlighting in the view, light from oncoming vehicles, abrupt change of brightness with a quick bright/dark jump (tunnel entrance/exit), driving on surfaces with strong reflective



properties (road surface covered with water or snow), tunnels, inside a building etc.

- The front view camera is partially or fully blocked by obstacles, e.g. dust, foreign objects, oil pollution, mud, snow, excessive water (rain), frost or water spray from the road on the windscreen.
- The windscreen in view is damaged.
- Not calibrated after removing/refitting the front view camera or the windscreen.
- The front view camera is not secured in place.

### **Description of Front Detection Radar**

#### **Calibration of front detection radar**

The front detection radar re-calibration is required after any of the following:

- The front detection radar mis-alignment failure, for example the position of the front detection radar has changed.
- Remove/refit the front detection radar or radar bracket.
- Remove/refit the front anti-collision beam.
- The four-wheel alignment parameters have changed.

**Note:** *If the front detection radar is subject to strong vibration or slight impact, the mounting position of the front detection radar needs to be checked and re-calibrated as necessary.*

**Note:** *The calibration of front detection radar requires professional knowledge and tools. If calibration is required, please seek an MG Authorised Repairer.*

#### **Front radar performance will be effected in the following situations:**

- When the front detection radar is covered by mud, snow, excessive water (rain) or water spray from the road.
- When the radar or surrounding areas are covered by objects such as labels or auxiliary lighting installation.
- When the front detection radar is subject to strong vibration or slight impact.
- Some targets may affect and weaken the detection capability of the front detection radar, such as road barriers, fences and tunnel entrances.

## STARTING & DRIVING

---

- When the front detection radar is affected by the environment, such as strong electromagnetic field interference or due to the target itself.
- Strong reflected radar signals (such as: in multi-storey car parks, tunnels, sprinkler spray systems or water jets etc). Experiencing any of these could cause the function of the front detection radar to be effected.

**Note:** *Any snow that gathers on the front radar may be removed using a soft brush, and any ice should be removed using a propriety deicing spray.*

**Note:** *Avoid any collision or contact with the front radar module, this may cause misalignment.*

### Speed Assist System



**The intelligent speed limit is an auxiliary function, it may display an incorrect speed limit value or no speed limit value in the instrument pack due to various factors. As a result, the vehicle speed is not restricted within the correct range. The driver still needs to observe the speed limit of the road traffic, and speeding is strictly prohibited.**



**The front view camera cannot recognise speed limit signs painted on the road surface. The driver *MUST* observe these speed limits and adjust the their speed accordingly.**

The speed assist system settings are available via the infotainment system. When the adaptive cruise control system is OFF, the following three functions can be selected:



- 1 **Speed Limit Information Function (SLIF):** The vehicle detects a speed limit sign (as shown above) at the roadside with the front view camera. The speed limit sign identified will be displayed in the instrument pack. When the vehicle speed exceeds the speed limit by a preset amount, a visual warning in the instrument pack will flash.
- 2 **Manual Speed Assist (MSA):** The driver sets the maximum speed using the adaptive cruise control lever. The system will actively intervene and keep the vehicle speed within the permitted maximum speed limit. An acoustic warning and a visual warning will be utilised during the intervention. Please refer to the section “Speed settings of manual speed assist”.
- 3 **Intelligent Speed Assist (ISA):** The vehicle detects a speed limit sign (as shown above) at the roadside with the front view camera. The speed limit sign identified will be displayed in the instrument pack. The system will automatically intervene and maintain speed control to keep the vehicle speed within the permitted maximum speed limit. An acoustic warning and a visual warning will be utilised when over speed.

### **Speed assistance system setting**

The operating interface for the speed assistance system is located in the infotainment display. Enter the vehicle setting interface to locate the driving assist option, scroll across the page to find the setting interface for the speed assistance system:

- 1 Touch the corresponding button on the infotainment display to select the speed assist mode: speed limit information function, manual speed assist and intelligent speed assist.

### **Speed settings of manual speed assist:**

After the manual speed assist function is enabled, the speed limit value can be set by using the adaptive cruise control lever as follows:

- 1 Moving the control lever up to adjust the speed limit. After the speed limit value is displayed in the instrument pack, press the SET button (3 in the figure below), the manual speed assist function will be activated. When pressing the SET button, if the actual speed value is smaller than setting, the speed limit value displayed in the instrument pack will be defined

## STARTING & DRIVING

as setting. If the actual speed value is larger than speed limit adjusted, the speed limit value displayed in the instrument pack will be defined as the current actual speed and rounded to the nearest value of 5mph (62mph will be defined as 65mph). The speed range is 20mph - 80mph. Moving the lever up or down once will increase or decrease the speed limit value by 5mph. Holding the lever up or down will continuously change the speed limit value in units of 5mph.

- 2 After the manual speed assist function is activated, the system will actively intervene and keep the vehicle speed within the target speed limit. If the current actual speed exceeds the target speed limit value set by the driver, the system will reduce the speed until it is below the target speed limit.
- 3 After the manual speed assist function is activated, the driver can press the SET button (3 in the figure below) on the adaptive cruise control lever to reinstate the system to standby state. Press the SET button again, the manual speed assist function will be resumed.

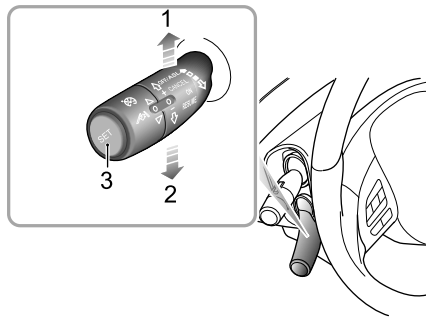

When the speed limit information function or intelligent speed assist function is enabled, the speed limit value indication illuminates. The “NNN” is displayed as “—”. When the vehicle passes the first speed limit sign identified, the speed limit indication displays the real-time speed limit value.

**Note:** When the vehicle needs to change lane, make a turn or turn around at an intersection and the driver uses an indicator in advance and slows down, the original speed limit value on the instrument pack will be reset until a new speed limit sign is detected. If the conditions are not met, the original speed limit value will be maintained and not be reset. The driver **MUST** observe the speed limits and adjust their speed accordingly.



When the national speed limit sign is identified and the speed limit information function or intelligent speed assist function is enabled, the national speed limit indication illuminates. These two functions will work using 60mph as the national speed limit.



When the intelligent speed assist function is enabled, the system indicator lamp in the instrument pack illuminates green. If the intelligent speed assist function detects a fault or failure, the indicator lamp will flash yellow then extinguish. Please try to restart this function. If

this function cannot be turned on, please contact an MG Authorised Repairer.



When the speed limit information function or intelligent speed assist function is enabled, and the front view camera detects a speed limit sign with text message below, the warning lamp illuminates yellow to remind the driver to recognise the text message by themselves. The camera cannot recognise the text messages provided below the speed limit sign, such as auxiliary lane, 100mls ahead, school section, 7:00-10:00. The camera will recognise the speed limit sign with text messages as a normal speed limit sign. The driver is required to make correct judgement according to the text message.



When the manual speed assist function is enabled, the system indicator lamp in the instrument pack illuminates white. When the function is activated by pressing the SET button on the adaptive cruise control lever, the system indicator lamp illuminates green. If the actual speed exceeds the maximum value that can be set, the system will remain in the standby state, and the

## STARTING & DRIVING

---

indicator lamp remains white. If the manual speed assist function detects a fault or failure, the indicator lamp will flash yellow then extinguish. Please try to restart this function. If this function cannot be turned on, please contact an MG Authorised Repairer.

When the manual speed assist function is enabled, the “NNN” is displayed as “—”. Move the adaptive cruise control lever up and down to adjust the target speed limit value. The “NNN” will now show the adjusted speed limit value.

The driver can directly switch off, or temporarily suspend the speed assist system by carry out the following actions:

- 1 To temporarily exceed the speed limit (overtaking manoeuvre), press the accelerator pedal hard. The indicator lamp in the instrument pack illuminates green, and the speed limit value flashes.
- 2 Gently press the SET button on the end of the adaptive cruise control lever; the indicator lamp in the instrument pack will change to yellow. Press the SET button again to resume the functions.

- 3 Move the adaptive cruise control lever to the “ON” position to switch the speed assistance system off. Then the indicator lamp in the instrument pack will extinguish.

**The speed limit information function and intelligent speed limit function may be impaired in the following situations:**

- 1 The detection performance of front view camera is affected.
- 2 The vehicle is driven at a high speed.
- 3 The speed limit signs are obscured by trees along the road, ice/frost, snow, dust, etc.
- 4 The speed limit signs are incorrectly placed or damaged.
- 5 There are multiple speed limit signs above the lane or on the sides of the road. Currently, the front view camera can only recognise the speed limit signs for the lane in which the vehicle is being driven.

- 6 Non standard speed limit signs or signs that contain additional information.
- 7 The speed limit signs set up at a fork in the road, on a bend or on-ramp/off-ramp.
- 8 During manoeuvres such as lane-changing.

### IMPORTANT

- The camera may not correctly recognise speed limit signs during poor lighting conditions, bad weather, non-standardized or sheltered speed limit signs or the camera's own restrictions which include the recognition of similar signs (e.g., recognise a weight limit sign as a speed limit sign, or recognise a minimum speed sign as the maximum speed sign).
- Some drastic or rapid steering operations made by the driver may be judged as changing lane or turning around at an intersection by the system. This will result in the identified speed limit signs being cleared.

### Lane Assist System



*The lane assist system is an auxiliary system that provides assistance to the driver. It does NOT remove the responsibility of safe driving from the driver. When choosing to use the lane assist system, the driver MUST always pay attention to the surroundings, hold the steering wheel and be prepared to make manoeuvres at any time. Failure to maintain overall control of the vehicle may result in an accident or personal injury.*



*The lane assist system does not always recognise the lane lines. Sometimes poor road surfaces, certain road structures or objects may be mistaken for lane lines. When such situations occur, the lane assist system must be immediately turned off.*

The lane assist system switch is located in the infotainment display. Enter the corresponding interface for driving

## STARTING & DRIVING

---

assistance to turn the system ON/OFF, and make mode selection.

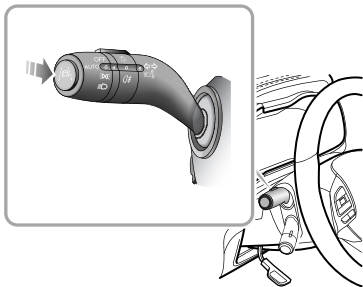

Having turned the lane assist system ON in the infotainment display, press the button at the end of the indicator stalk switch (as shown above), the system will enter the standby or active state.

### Alert

The system uses the front view camera to detect the lane lines ahead of the vehicle. The system will be activated when the following detection conditions are met:

- The function is switched ON.
- Vehicle speed is above 37 mph (60 km/h).
- Lane line markings are clear, the system recognises at least one lane line.

When a wheel is about to cross the lane line, or has already crossed the line, the system will provide warnings to prompt the driver to take action and maintain the vehicle position between the lane lines. The function will automatically exit when the vehicle speed drops below 33 mph (55 km/h).

### Departure assist

The system uses the front view camera to detect the lane lines ahead of the vehicle. The system will be activated when the following detection conditions are met:

- The function is switched ON.
- Vehicle speed is above 37 mph (60 km/h).



- Lane line markings are clear, the system recognises at least one lane line.

When a wheel is about to cross the lane line, has already crossed the line, the system will provide assistance to the driver by keeping the vehicle in between the lane lines by applying corrective steering intervention and simultaneously displaying a prompt. The function will automatically exit when the vehicle speed drops below 33 mph (55 km/h).

In cases of several interventions within a certain period of time and in the absence of detecting any steering input by the driver during the interventions, the system will provide warnings.

## Lane keeping

The system uses the front view camera to detect the lane lines ahead of the vehicle. The system will be activated when the following detection conditions are met:

- The function is switched ON.
- Vehicle speed is above 37 mph (60 km/h).
- Lane line markings are clear, the system recognises two lane lines on both sides.

When a wheel is about to cross the lane line, or has already crossed the line, the system will always attempt to maintain the vehicle position in the centre of the lane by using corrective steering interventions. The function will automatically exit when the vehicle speed drops below 33 mph (55 km/h).

In the absence of a steering input from the driver for a certain period of time, the system will provide warnings.

### IMPORTANT

- In cases where the number of lanes increase or lanes merge, the driver **MUST** take full control of the vehicle.
- In areas where there are complex traffic conditions such as intersections or road junctions with congestion, the driver **MUST** take full control of the vehicle.

**The lane assist system will be impaired or ineffective in the following conditions:**

- The hazard lamps are activated.

## STARTING & DRIVING

---

- The driver indicates in the direction of the lane line about to be crossed.
- The driver applies the accelerator rapidly, carries out an emergency manoeuvre or makes a hard brake pedal application.
- The system detects that the driver has not moved the steering wheel for a preset time period (in the mode of 'departure assist' or 'lane keeping').
- During system intervention the steering wheel is operated (in the mode of 'departure assist' or 'lane keeping').
- The lane line is too thin, damaged, or fuzzy.
- The vehicle is driven on the bend with a small curvature radius, the road is too narrow or too wide.
- The vehicle has just entered a road section with lane lines or is driven on a road section without lane lines.
- The vehicle changes lanes or sways laterally too fast.
- The vehicle is not in D.
- The vehicle speed is below 33 mph (55 km/h), or too high.
- The anti-lock brake system (ABS) and the dynamic stability control system (SCS) are activated.

- Faults exist in the anti-lock brake system (ABS), dynamic stability control system (SCS), electric power steering system (EPS), etc.

### **It is recommended to turn off the lane assist system in the following situations:**

- Driving in a sports style or manner.
- Driving in bad weather conditions.
- Driving on rough or poor road surfaces.
- Driving through roadworks or construction sites.

### MG Pilot System



**MG Pilot is an auxiliary system that provides assistance to the driver. It does NOT remove the responsibility of safe driving from the driver. When choosing to use the MG Pilot system, due to the limitations of system detection and control, the driver must always be careful and hold the steering wheel at all times. The driver needs to correct or take over the steering wheel control if necessary. Failure to maintain overall control of the vehicle may result in an accident or personal injury.**

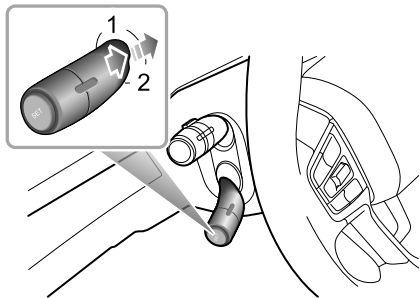

The MG Pilot system switch is located in the infotainment display. Enter the corresponding interface for driving assistance to turn the system ON/OFF. Operating the adaptive cruise control level to “RESUME” twice will switch the MG Pilot system to standby or active state.

The MG Pilot system works on the basis of the adaptive cruise control system. The system will operate when the following conditions are met:

- The adaptive cruise control system is activated.

## STARTING & DRIVING

---

- The MG Pilot system is switched on via the corresponding button in the infotainment system.
- The system detects lane lines on both sides of the vehicle.
- The vehicle is in D.

If the lane lines ahead on both sides are clear, the system can assist the vehicle in driving within the lane lines. When driving at low speed, if there is a vehicle ahead and the lane lines ahead on both sides are not clear, the system can provide assistance in following the track of the vehicle ahead.

In the absence of a steering input from the driver for a preset period of time, the system will provide warnings.

**Note: The driver should adjust the vehicle speed and the following distance according to road visibility, weather and road conditions. The MG Pilot system does not respond to pedestrians, animals, stationary vehicles and vehicles that drive across the lane or oncoming vehicles in the same lane. If the MG Pilot system cannot reduce the vehicle speed timely and effectively, the driver MUST apply the brakes. In congested conditions, should another vehicle cut into**

**the lane being used by the vehicle under MG Pilot control, the system may not detect the vehicle in adequate time to make a braking manoeuvre. In this case the brakes should be applied by the driver.**

**The MG Pilot system will be impaired or ineffective in the following conditions:**

- The hazard lamps are activated.
- The driver indicates in the direction of the lane line about to be crossed.
- The driver applies the accelerator rapidly, carries out an emergency manoeuvre or makes a hard brake pedal application.
- The system detects that the driver has not moved the steering wheel for a preset time period.
- During system intervention, the steering wheel is being manipulated by the driver.
- The lane line is too thin, damaged, or fuzzy.
- The vehicle is driven on a bend with a small curvature radius, the road is too narrow or too wide.
- The vehicle has just entered a road section with lane lines or is driven on a road section without lane lines.

- The vehicle is not in D.
- The vehicle changes lanes or sways laterally too fast.
- The anti-lock brake system (ABS) and the dynamic stability control system (SCS) are activated.
- Faults exist in the anti-lock brake system (ABS), dynamic stability control system (SCS), electric power steering system (EPS), etc.

**It is recommended to turn off the MG Pilot system in the following situations:**

- Driving in a sports style or manner.
- Driving in bad weather conditions.
- Driving on rough or poor road surfaces.
- Driving through roadworks or construction sites.
- Driving on steep, winding or slippery roads (such as snow and ice roads, wet roads and roads with water).
- Driving on grass tracks or unpaved roads.

### IMPORTANT

- In cases where the number of lanes increase or lanes merge the driver **MUST** take full control of the vehicle.
- In areas where there are complex traffic conditions such as intersections or road junctions with congestion, the driver **MUST** take full control.
- The driver **MUST** be aware of the surroundings and be able to assume full control of the vehicle when using the MG Pilot function to track the car in front should the need arise.

## STARTING & DRIVING

---

### Forward Collision System



*The driver remains responsible for the safety of the entire driving process, even if the vehicle is equipped with a forward collision system. The driver **MUST** pay full attention and drive carefully. As with all the driver assist systems, the forward collision system cannot prevent accidents or avoid collisions in all situations. The driver **MUST** always remain in control to avoid accidents or emergency situations.*



*Emergency braking whilst under the control of the forward collision system may cause injuries to the passengers. Therefore, drive carefully and all passengers **MUST** wear seat belts at all times.*



*Ensure the forward collision system or vehicle power system is switched off when being towed. If the forward collision system is enabled when the vehicle is being towed, adverse effects may affect the safety of your vehicle, the towing vehicle and the people around.*



*To avoid the occurrence of accidents, never specially test the functions of the forward collision system.*

The forward collision system switch is located in the infotainment display. Enter the corresponding interface for driving assistance to turn the system ON/OFF, and make mode selection.

### Alert

When the system detects that there is a risk of collision between the vehicle and the vehicle in front of the lane, warnings will be provided to prompt the driver to slow down in time and keep a relatively safe distance from the vehicle ahead.

### Emergency braking

When the system detects that there is a risk of collision between the vehicle and the vehicle or the mobile pedestrian directly in front of the vehicle, the brake system will automatically intervene to decelerate the vehicle, so as to avoid collision accidents or mitigate damage from collision accidents. If the vehicle is braked and stopped under the system control, it will remain stationary for a short time. Full control of the vehicle will then be returned to the driver.

The system will only slow down the vehicle automatically if the following conditions are met:

- The dynamic stability control system (SCS) and traction control system (TCS) are fault-free and ON.
- The vehicle is in D or N.
- The airbags are not deployed.

**Note:** *When the vehicle is braked under system control, the brake pedal will automatically sink. DO NOT place your foot under or behind the brake pedal to prevent pinching.*

**Note:** *In some cases, the driver may not have anticipated any braking intervention and does not want to apply the brakes whilst the forward collision system is braking heavily, the driver can temporarily cancel this operation by heavily pressing the accelerator pedal after ensuring that it is safe to do so.*

**The operation of the forward collision system may be impaired or ineffective in the following situations:**

- The vehicle ahead approaches head-on, crosses the intersection or jumps the queue rapidly in a short distance.
- The vehicle ahead does not follow the rules of driving and parking (such as drives on the lane lines).
- The vehicle ahead is not in the same lane as your vehicle or the vehicle ahead is partially obscured.
- The vehicle ahead is an abnormal vehicle (modified or abnormal shape).
- The vehicle ahead is a vehicle with higher chassis.

## STARTING & DRIVING

---

- The vehicle ahead is large vehicle at close range (such as tractor, trailer, towing vehicle, mud truck, sanitation truck, sprinkler truck etc.).
- The vehicle ahead is unusual transportation (such as a horse, cart, carriages etc.).
- The system detects the side of a vehicle.
- The contour of the vehicle ahead is unclear (such as water being sprayed by the wheels of the front and surrounding vehicles).
- The vehicle ahead does not have or has obscured tail lamps when driving at night or in a tunnel.
- The tail lamps of the vehicle ahead are all LED strip lights or other homemade coloured lamps.
- The street lights are inconsistent or flickering when driving at night.
- The pedestrian is not directly in front of the vehicle, or the pedestrian is not fully visible.
- The pedestrian is not standing upright, or it is a child under a certain height.
- In front of the vehicle are a crowd of pedestrians, the pedestrian is over-shadowed or in the dark.
- There are animals in front of the vehicle.
- Objects such as special-shaped ground obstacles (e.g. roadblocks, isolation piles, isolation strips, large stones, other scattered objects etc.) are detected in front of the vehicle.
- Objects such as signs, guardrails, bridges, buildings or other are detected in front of the vehicle.
- The vehicle is being driven on hillside road, upper and lower bridge section or tight bend.
- The vehicle is in R.
- The vehicle is in the state of braking or rapid acceleration.



## Parking Aid

### Ultrasonic Sensor Parking Aid



*The purpose of the parking aid is to assist the driver in reversing! The sensors may not be able to detect certain types of obstruction, e.g. narrow posts or small objects no more than a few inches wide, small objects close to the ground, objects above the tail gate and some objects with nonreflective surfaces.*



*Keep the sensors free from dirt, ice and snow. If deposits build up on the surface of the sensors, their performance may be impaired. When washing the car, avoid aiming high pressure water jets directly at the sensors from close range.*

### Rear Parking Aid

The ultrasonic sensors in the rear bumper monitor the area behind the vehicle to search for obstacles. If an obstruction is detected, the system calculates its distance from the rear of the car and communicates this information to the driver by sound warning chimes.

### Parking Aid Operation

The rear parking aid is enabled automatically when reverse gear is selected, it is switched off as soon as reverse gear is disengaged. A short beep is given by the parking aid within 1 second after selecting reverse gear to indicate that the system is operating normally.

**Note:** *If a longer, higher pitched sound is emitted for 3 seconds when reverse gear is selected, this indicates a fault in the system. In this case seek assistance from your MG Authorised Repairer.*

With the parking aid function enabled, if an obstruction is detected, the audible sounds in different frequencies are transmitted (there might be blind zones).

## STARTING & DRIVING

- If an obstruction is located within 1.2m range of the rear parking aid sensors, the warning commences. As the car moves closer to the obstruction, the audible sounds are transmitted more rapidly.
- Once the obstruction is within 30cm range of the rear bumper, the audible sounds will merge into a continuous warning.

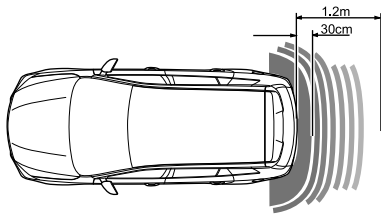

### Parking Camera



***The purpose of the parking camera system is to assist the driver in reversing! The camera has limited field of view and cannot detect obstructions outside the field of view.***

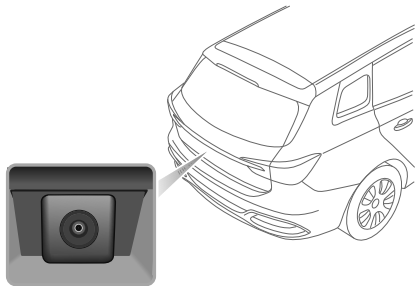

A rear parking camera is fitted between the license plate lamps. When reverse gear is selected, the camera will

display an image of what is immediately behind the car. This image will be shown on the entertainment system screen.

Models fitted with the parking camera system display an overlay grid on the camera image in the entertainment display to assist parking, this is supported by the silhouette image showing object distance from each sensor.

# STARTING & DRIVING

## Load Carrying



**DO NOT** exceed the *gross vehicle weight* or the *permitted front and rear axle loads*. *Failure may result in vehicle damage or serious injury.*

## Loadspace Loading



**Ensure** that the *rear seat backrests are securely latched in the upright position when loads are carried in the load space behind the seats.*

When luggage is carried in the load space, always ensure heavy items are placed as low and as far forward as possible, so as to avoid the cargo shift in the event of an accident or sudden stop.

Drive carefully and avoid emergency braking or manoeuvres.

Driving with the tailgate open is very dangerous. If the load being carried requires the tailgate to be open, please ensure the cargo is suitably secured.

### IMPORTANT

Traffic regulations must be observed when loading cargo, if the cargo extrudes the loadspace appropriate warning measures must be taken to warn other road users.

## Internal Loading



**DO NOT** carry *unsecured equipment, tools or luggage that could move, causing personal injury in the event of an accident, or emergency braking or hard acceleration.*



**DO NOT** *obstruct the driver's or passenger's vision with loads.*

Folding the rear seats can increase luggage space, refer to "Rear Seats" described in the "Seats and Restraints" section.

When cargo is loaded in the vehicle, place it at a position as low as possible and ensure that it is tightly secured, so as to avoid personal injury caused by cargo movement when traffic accidents or emergency braking occurs. If the cargo

has to be placed on a seat, then the seat must not be used by an occupant during that time.



## **Emergency Information**

---

- 218 Hazard Warning Devices*
- 219 eCall - SOS Emergency Assistance*
- 221 Emergency Starting*
- 224 Vehicle Recovery*
- 228 Tyre Repair and Wheel Replacement*
- 235 Fuse Replacement*
- 243 Bulb Replacement*

# EMERGENCY INFORMATION

---

## Hazard Warning Devices

### Hazard Warning Lights

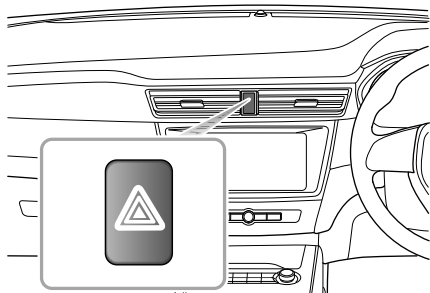

**Note:** Before you stop or slow the car in an emergency, always press the hazard warning switch. All the direction indicators will flash together to warn other road users when your car is causing an obstruction or is in a hazardous situation. Remember to switch off before driving away.

## Warning Triangle

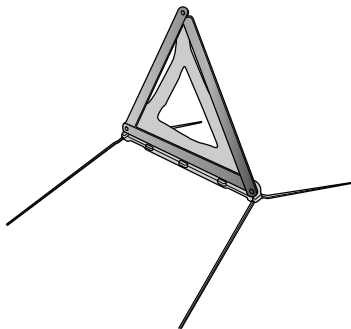

The warning triangle supplied with your car is stowed in the loadspace.

If you have to stop your car on the road in an emergency, you must place a warning triangle approximately 50 - 150 metres behind the car, if possible, to warn other road users of your position.



### eCall - SOS Emergency Assistance

In an accident, your vehicle's eCall – SOS Emergency Assistance can either be triggered manually or in severe cases automatically upon detection by vehicle sensors. The eCall service is a public service and is accessible free of charge. The emergency call centre will establish verbal communication with the vehicle occupants in order to understand the extent of the emergency and the level of assistance required. If verbal communication is not achievable an attempt will be made to send the following vehicle information to the emergency call centre. The appropriate emergency services will be deployed to the vehicle's current location if known.

- Current time, location and direction of travel
- Vehicle type
- Vehicle identification number (VIN)
- Whether the call was automatically or manually initiated
- Vehicle category

This system will ensure that your personal data is securely protected. It is designed to ensure that it is not traceable and other external systems are not available. When the

eCall triggers, the system will only transmit the data information to the relevant public safety answering points designated by the respective public authorities of the country on which territory they are located, which will receive and process your emergency call request. The system will retain data locally for 13 hours after triggering.

You have the right to access the data information stored in this system, and to request the rectification, erasure or blocking of data information that does not meet the requirements of the regulations. When you think your personal data is infringed, you have the right to complain to the competent data protection authority.

For manual activation, press and release the SOS button in the overhead console for 1 second to activate an emergency services call. A single beep will be heard when the eCall is triggered and a message will be displayed on the vehicle's message centre and entertainment player. The entertainment player will be muted whilst the emergency services call is active. Manually triggered emergency service calls may be cancelled by pressing and releasing the SOS button again within 5 seconds of the initial press, two beeps will be heard confirming that the emergency

## EMERGENCY INFORMATION

---

services call has been cancelled and the messages will be removed.

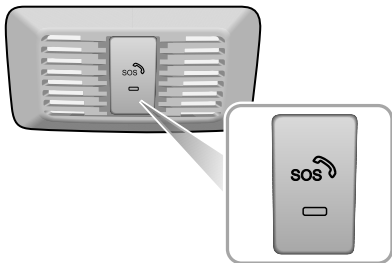

The emergency services call (eCall) system will perform a self-test when the vehicle power system is ON. During a Self-Test the emergency services call (eCall) LED status indicator on the SOS button will flash quickly until completion. The LED status indicator will be illuminated solid if no system faults are present. The LED status indicator will not illuminate or flash slowly if a fault is

detected. Faults detected during the self-test will be displayed on the vehicles message centre.

**Note:** *The operation of eCall - SOS Emergency Assistance relies on cellular coverage and may be affected by signal outages or low signal strength.*

**Note:** *The automatic emergency services call (eCall) function may be disabled by the local MG Authorised Repairer upon request.*

### Emergency Starting

#### Using Booster Cables

 **NEVER** attempt to power the vehicle by pushing or towing.

 **Make sure that both batteries are of the same rated voltage (12 volts), and that the booster cables are approved for use with 12 volt car batteries.**

 **Ensure sparks and naked flames are kept well away from the front compartment.**

Using booster cables (jump leads) from a donor battery, or a battery fitted to a donor vehicle, is the only approved method of powering a car with a flat battery.

If the battery from a donor vehicle is to be used, make sure that the vehicles are parked so that the two batteries are adjacent to one another and that both the vehicles do not touch.

#### Starting the Car



**Ensure that each booster cable connection is securely made. There must be no risk of the clips accidentally slipping from the battery terminals, this could cause sparking, which could lead to fire or explosion.**

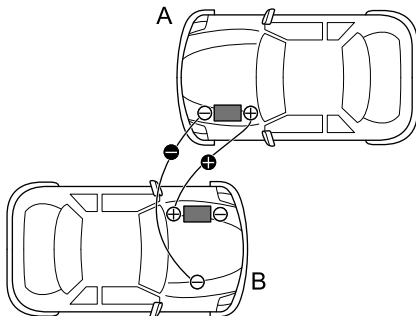

## EMERGENCY INFORMATION

---

Ensure the START/STOP Switch is turned off and switch off ALL electrical equipment of BOTH vehicles, then follow the instructions below:

- 1 Connect the RED booster cable between the positive (+) terminals of both batteries. Connect the BLACK booster cable from the negative (-) terminal of the donor battery (A) to a good earth point (the CCU mounting or other unpainted surface, for example), as far away from the battery as possible and well away from brake lines on the disabled vehicle (B).

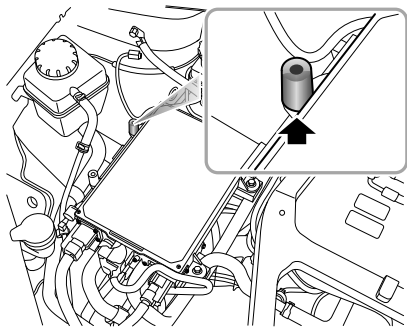

- 2 Start the donor vehicle and allow it to run for a few minutes.
- 3 Now switch the vehicle power system of the vehicle with the discharged battery to READY. If the disabled vehicle will not switch to READY it may need to be repaired. Please contact an MG Authorised Repairer.
- 4 After both the vehicles have normally started/powerd, leave the vehicles connected in this

state for more than 2 minutes before switch off the donor vehicle and disconnecting the booster cables.

**IMPORTANT**

DO NOT switch on any electrical appliance in the disabled vehicle until the booster cables have been disconnected.

- 5 Disconnecting the booster cables must be an exact reversal of the procedure used to connect them, i.e. disconnect the BLACK cable from the earth point on the disabled vehicle FIRST.

**Note:** *It is recommended to ensure that the disabled vehicle remains powered or runs for more than 1 hour after it is started, in order to recover the battery power.*

# EMERGENCY INFORMATION

---

## Vehicle Recovery

### Towing Vehicle



*When pushing or towing the vehicle from a dangerous situation or onto the transporter, the speed must remain below 3mph (5km/h) and be completed within 3 minutes.*



*When pushing or towing the vehicle onto the transporter, the driver's side seat belt should be inserted into the lock and maintained in the inserted state in order to release the EPB.*

### Towing Hook



*DO NOT use a tow rope that is twisted - or the towing hook may be unscrewed.*



*DO NOT tow the vehicle with the driven front wheels in contact with the road surface.*

## EMERGENCY INFORMATION

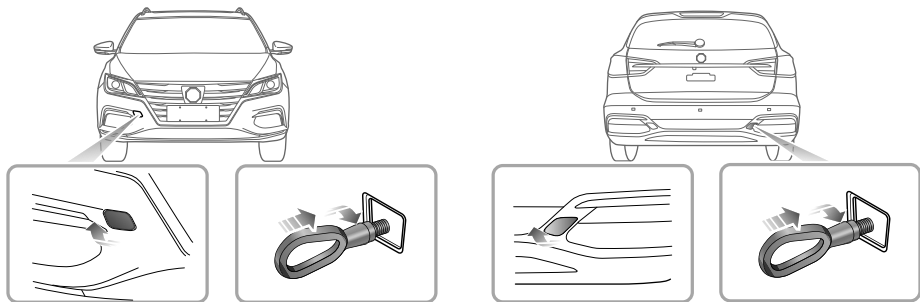

5

Your car is equipped with 2 towing eyes (located at the front and the rear of the vehicle), which are used for fitting the towing hook in the tool kit. The tool kit is placed beneath the loadspace floor.

To fit the towing hook, remove the small cover set into the bumper, then screw the towing hook via the small hole into the threaded hole in the bumper beam (see illustration). Ensure the towing hook is fully tightened!

**Note:** *The towing eye cover may be secured to the bumper by a plastic cord.*

Both towing points are intended for use by qualified recovery specialists to assist in the recovery of your car when a breakdown or accident occur. They are not designed for towing other vehicles, and must **NEVER** be used to tow a trailer or caravan.

# EMERGENCY INFORMATION

---

## Towing for Recovery



*If, due to an electrical fault, potential safety hazards may exist, please ensure the vehicle power system is switched OFF.*



*When towing, DO NOT accelerate or brake suddenly, this can cause accidents.*



*DO NOT tow the vehicle with all 4 wheels in contact with the road, this will cause damage to the electric drive transmission.*

## Suspended Towing



*When using suspended towing, be careful not to let the high voltage battery pack touch the ground.*

Suspended towing is the best method for a vehicle that needs to be towed. The driven wheels **MUST** be suspended above the ground, this is to avoid any damage to electric drive transmission and possible inadvertent powering of

the vehicle. Ensure the EPB is released, the hazard lamps are ON and no passengers are in the vehicle.

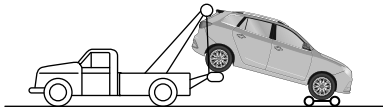
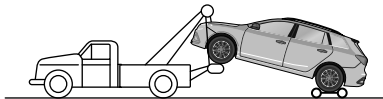
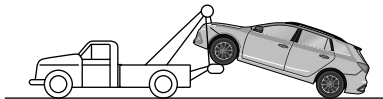



### Transporter or Trailer with Rope

If your car is to be transported on the back of a trailer or transporter, it must be secured as illustrated:

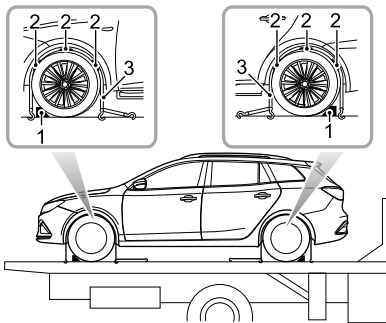

- 1 Apply the parking brake and place the electric drive transmission in park.
- 2 Fit wheel chocks (1) as shown, then position the anti slip rubber blocks (2) around the circumference of the tyre.

- 3 Fit the lashing straps (3) around the wheels and secure to the trailer. Tighten the straps until the car is securely held.

# EMERGENCY INFORMATION

## Tyre Repair and Wheel Replacement

### Tool Identification

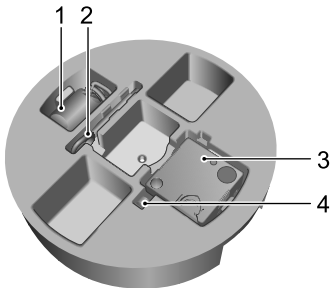

- 1 Repair Fluid Reservoir
- 2 Towing Hook
- 3 Electric Air Pump
- 4 Wheel Bolt Cap Removal Tool

### Tyre Repair

- 1 Remove the label at the bottom of the repair fluid reservoir and attach it to the steering wheel to remind the driver not to exceed 50 mph (80 km/h).

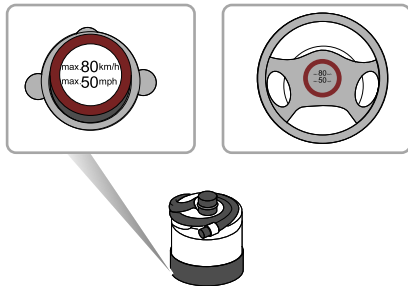

- 2 Connect the air hose of the electric air pump to the repair fluid reservoir, fit the tyre sealant bottle (upright) into the slot on the compressor. Remove the valve dust cap of the flat tyre, and connect the filler hose from the tyre sealant bottle to the tyre

## EMERGENCY INFORMATION

valve. Ensure that the power switch of the electric air compressor is switched off (i.e., press “O”), then insert the plug from the compressor into the centre console power socket, and turn the vehicle power system to ON/READY.



**Note:** To avoid battery discharge, it is recommended to keep the vehicle in P and READY mode.

- 3 Switch on the power switch of the electric compressor (i.e., press “-”), to start pumping sealant into the tyre. The tyre sealant bottle will become empty after approximately 30 seconds. The tyre should reach the specified pressure within 5 or 10 minutes.

**Note:** The pressure gauge may briefly reach 6 bar (87 psi), then the pressure begins to drop to normal.

- 4 When the required pressure is reached, switch off the power switch of the electric compressor (i.e., press “O”).

**Note:** If the required pressure cannot be reached within 10 minutes, please disconnect the compressor, drive the vehicle 10 metres (33 feet) approx forward or backward to allow the sealant to spread within the tyre. If the required pressure can still not be reached, the tyre is severely damaged and you should seek assistance from the MG Authorised Repairer.

## EMERGENCY INFORMATION

**Note:** *Consecutive operation of Electric air compressor for more than 10 minutes may result in damage to the compressor.*

**Note:** *Under no circumstances should you continue your journey with a deflated tyre. Driving a vehicle with a deflated tyre is extremely dangerous.*

- 5 Remove the tyre sealant bottle from the slot in the compressor, disconnect the hose from the tyre valve, remove the compressor plug from the centre console power socket, return the tyre repair kit to its stowage tray.
- 6 Please drive the vehicle within one minute after completing the above operations, so that the sealant is evenly distributed in the tyre. Please **DO NOT** drive exceed 50 mph (80 km/h).

Please take different measures based on the tyre pressure measured:

If the tyre pressure has dropped to less than 0.8 bar (11.6 psi), do not continue driving, seek assistance instead.

If the tyre pressure is between 0.8 bar (11.6 psi) and specified pressure, connect the hose of electric air pump to the tyre valve, and connect the plug of the electric air pump to the power socket, then switch on the electric air pump to inflate the tyre until it reaches the specified pressure. Repeat the operations of step 6 after driving a maximum distance of 3 miles (5 km).



If the tyre pressure has not dropped, you may continue driving, but the vehicle speed must not exceed 50 mph

## EMERGENCY INFORMATION

(80 km/h), and the driving mileage must not exceed 125 miles (200 km).

**Note:** *DO NOT* remove foreign objects (eg. screws,nails) from the tyre. The tyre repair system must only be used when the foreign object is in the tread pattern (A), *DO NOT* attempt a repair when the damage is in the sidewall of the tyre (B).

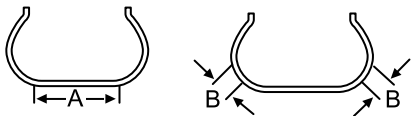

### Changing a Wheel \*

If you need to change the wheel during the journey, choose a safe place to stop away from the main road if possible. Always ask your passengers to get out of the car and wait in a safe area away from other traffic.

Switch on hazard warning lamps. If available, position a warning triangle about 50 to 150 metres behind your vehicle to warn approaching traffic.

Before changing a wheel, ensure the front wheels are in the straight ahead position. Apply the parking brake and place the electric drive transmission in park.

Observe the following precautions:

- Ensure the jack is positioned on firm, level ground.
- If the vehicle must be parked on the hill, place chocks in front of and behind other 3 wheels to prevent the vehicle moving.

### Positioning the Jack



**NEVER** work beneath the car with the jack as the only means of support. The jack is designed for wheel changing only!

## EMERGENCY INFORMATION



**NEVER jack the car using any areas other than the designated jacking points. Serious damage to the car could result.**

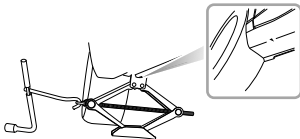
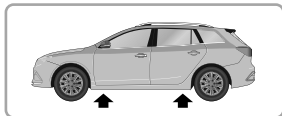

**Avoid accidental contact with any underbody parts, especially high voltage components.**

Position the jack on firm level ground under the jacking point nearest the wheel to be removed. Note that the

domed head of the jack must fit into the corresponding recess in the sill plate (There is a triangle indicator in the area shown by the arrowhead. See the illustration above).

Turning the jack screw by hand, adjust the jack until the jack head fits snugly onto the sill in the correct area. Ensure that the base of the jack is in full contact with the level ground.

### Fitting the Spare Wheel



**Regularly check the spare wheel tyre pressure, it may not be used for long periods of time. After fitment, at the first opportunity check and adjust the tyre pressure.**



**The wheel bolts must be tightened to the specified torque after changing a wheel (115 ~ 125 Nm).**

- Before raising the car, use the special tool supplied with the vehicle to remove each wheel bolt cap. Use the wheel bolt spanner to slacken each bolt half a turn anti-clockwise.

## EMERGENCY INFORMATION

- 2 Turn the handle in a clockwise direction until the tyre is clear of the ground.
- 3 Remove the wheel bolts and place them in the tool tray to prevent them from being lost. Make sure the vehicle is steady and there is no risk of slip or movement before removing wheel bolts.
- 4 Remove the road wheel.

**Note:** *Avoid placing wheels face down on the ground - the surface may be scratched.*

- 5 Fit the spare wheel and tighten the wheel bolts with wheel bolt spanner until the wheel is seated firmly against the hub.
- 6 Lower the car and remove the jack, then FULLY tighten the wheel bolts in a diagonal sequence.
- 7 Finally, return the tools to the toolbox, put the toolbox into the well of the boot floor, tighten the spare wheel retaining nuts, and put the replaced wheel above the toolbox in the well in the load space floor (face down). Lower the boot floor, and put the boot storage box on the boot floor.

**Note:** *DO NOT stand on the handle of the wheel bolt spanner or use extension tube on the handle of the spanner.*

**Note:** *When replacing the wheel, please fully tighten the bolts in the diagonal sequence twice.*

**Note:** *Consult your MG Authorised Repairer. or tyre specialist for a replacement tyre, as soon as possible.*

### Spacesaver Spare Wheel



**Only one spacesaver spare wheel can be used at any one time, otherwise the operational performance and brake performance may be reduced, thereby leading to accident or injury to yourself and others.**



**When driving on icy or slippery surfaces it is advised to fit the spacesaver wheel to the rear of the vehicle to maintain adequate stability. This may mean swapping a front wheel with a rear wheel.**

## EMERGENCY INFORMATION

---



***Snow chains can not be used on the spacesaver spare wheel, this can cause damage to the car and snow chain.***

When the spacesaver spare wheel is fitted, the vehicle speed should not exceed 50 mph (80 km/h). Please have the full-size tyre repaired and replace the spare wheel as soon as possible. This will extend the life span of the spare wheel for other emergencies.

***Note: DO NOT use an automatic car wash when the spacesaver wheel is fitted, the guide rails of the car wash may conflict with the wheel/tyre and cause damage.***



## Fuse Replacement

### Fuse

Fuses are simple circuit breakers which protect the car's electrical equipment by preventing the electrical circuits from being overloaded. A blown fuse may be indicated when the item of electrical equipment it protects stops working.

If you suspect a fuse it can be checked by removing it from the fuse box and looking for a break in the wire inside the fuse.

It is recommended to have spare fuses in the vehicle, which can be obtained from a local MG Authorised Repairer.

#### IMPORTANT

- NEVER attempt to repair a blown fuse. ALWAYS replace a fuse with one of the same rating, failure to use the correctly rated fuse could result in a fire or electrical circuit damage due to overloading.
- If a replaced fuse fails immediately, please contact an MG Authorised Repairer as soon as possible.

### Fuse Box

The vehicle is equipped with 2 fuse boxes:

- Passenger compartment fuse box (behind the driver side lower trim panel)
- Front compartment fuse box (front left of the front compartment)

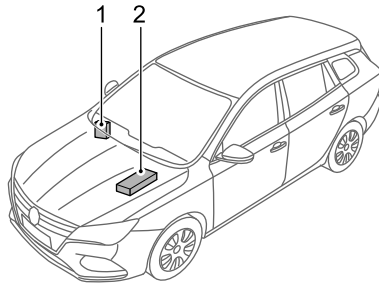

- 1 Passenger compartment fuse box
- 2 Front compartment fuse box

# EMERGENCY INFORMATION

## Passenger Compartment Fuse Box

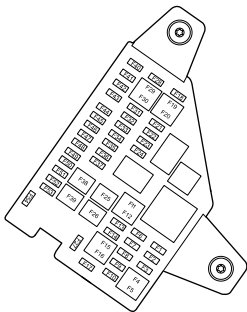

### Check or Replace a Fuse

- 1 Turn off the Start/Stop Switch and all electrical appliances, and disconnect the negative battery cable.
- 2 Remove the driver side dashboard end cover plate and lower trim panel to access the fuse box.

- 3 Check a suspect fuse by removing it from the fuse box and looking for a break in the wire inside the fuse.
- 4 If a fuse is blown, replace it with another fuse of the same type and same ampere value.

### Fuse Specification

Code	Specs	Function
F1	15A	Front Console Power Socket
F2	5A	Interior Mirror, Rear Console USB Charging Ports
F3-F17	-	-
F18	5A	TBOX, Vehicle Control Unit, Sensing Diagnostic Module (Airbag), Shifter Control Unit, Instrument Pack
F19	5A	AC Front Panel

## EMERGENCY INFORMATION

Code	Specs	Function
F20	10A	AC Control Module
F21	10A	Front Right Seat Heater
F22	5A	Diagnostic Socket
F23	10A	Front Left Seat Heater
F24	5A	PEPS Control Module
F25	-	-
F26	30A	Front Left Window Lift, Rear Right Window Lift
F27	-	-
F28	5A	Backup Immobilizer Coil
F29	15A	Entertainment System
F30	5A	Instrument Pack
F31	5A	EPB Switch
F32	5A	Rain Light Sensor

Code	Specs	Function
F33	10A	Sensing Diagnostic Module (Airbag)
F34	10A	Driver Door Switch Pack, Gateway
F35–F36	-	-
F37	25A	Driver Electric Seat Adjustment
F38	-	-
F39	40A	Blower
F40-F43	-	-
F44	5A	Radio Broadcasting Reception Module
F45	10A	Electronic Steering Column Lock
F46	-	-

## EMERGENCY INFORMATION

---

Code	Specs	Function
F47	5A	High Voltage Electric Heater
F48	-	-
F49	5A	TBOX
F50	10A	Gateway
F51	5A	Shifter Control Unit, Tyre Pressure Monitoring System
F52	5A	Door Mirrors and Headlamp Levelling Adjustment Switch
F53	5A	Pedestrian Alert Control Module
F54	-	-

# EMERGENCY INFORMATION

## Front Compartment Fuse Box

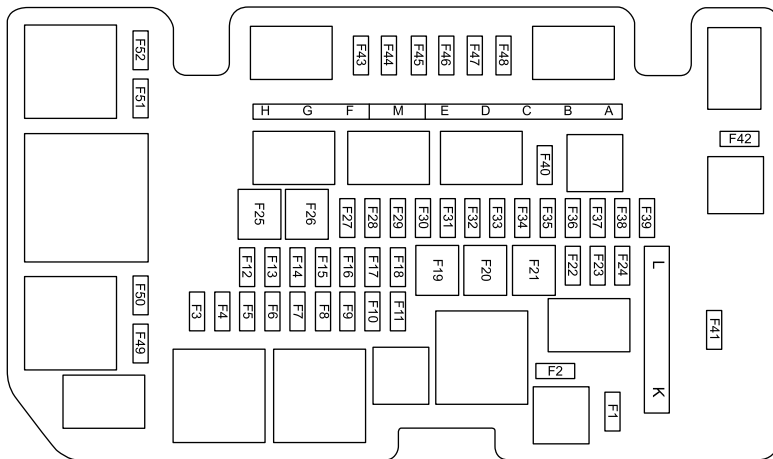

# EMERGENCY INFORMATION

## Check or Replace a Fuse

- 1 Turn off the Start/Stop Switch and all electrical appliances, and disconnect the negative battery cable.
- 2 Press the lock catch to open the upper cover of front compartment fuse box.
- 3 Check a suspect fuse by removing it from the fuse box and looking for a break in the wire inside the fuse.
- 4 If a fuse is blown, replace it with another fuse of the same type and same ampere value.

## Fuse Specification

Code	Specs	Function
F1	120 $\Omega$	On-board Network Terminal Resistance
F2	120 $\Omega$	On-board Network Terminal Resistance
F3	30A	Body Control Module
F4	20A	Body Control Module

Code	Specs	Function
F5	15A	Body Control Module
F6	5A	Charging Plug Latch
F7	5A	Vehicle Control Unit
F8	30A	Electric Parking Motor Control Unit
F9	15A	Horn Relay, Horn
F10	-	-
F11	15A	High Voltage Battery Pack, Electric Vehicle Communication Controller, Battery Heater
F12–F24	-	-
F25	30A	Driver Door Switch Pack, Driver Window Lift, Rear Left Window Lift

## EMERGENCY INFORMATION

Code	Specs	Function
F26	30A	Stability Control System (Valve)
F27	15A	Windscreen Washer System
F28	10A	Body Control Module
F29	20A	Body Control Module
F30	25A	Front Wiper System
F31	10A	Power Electronic Box
F32	25A	Body Control Module
F33	15A	Superlock System
F34	15A	Main relay, Power Electronic Box Water Pump, Brake Lamp Switch
F35	5A	Combined Charging Unit

Code	Specs	Function
F36	5A	Electric Air Conditioning Compressor
F37	10A	Main Beam Relay, Main beam
F38	15A	Rear Wiper System
F39	15A	High—Voltage Battery Pack Coolant Pump
F40-F42	-	-
F43	7.5A	Heated Exterior Rearview Mirror
F44	25A	Heated Rear Window
F45	-	-
F46	5A	Door Mirrors and Headlamp Levelling Adjustment Switch, Manual Headlamp Levelling
F47	-	-

## EMERGENCY INFORMATION

---

Code	Specs	Function
F48	5A	Charging Flap Motor
F49-F52	-	-
FUSE A	80A	Electric Power Steering Module
FUSE B	-	-
FUSE C	40A	Stability Control System (Pump)
FUSE D	-	-
FUSE E	-	-
FUSE F	30A	Electrical Parking Brake Control Module
FUSE G	50A	Cooling Fan
FUSE H	50A	iBooster
FUSE M	150A	Combined Charging Unit

Code	Specs	Function
FUSE L	30A	Electronic Parking Brake Control Module
FUSE K	100A	Passenger Compartment Fuse Box



## Bulb Replacement

### Bulb Specification

Bulb	Specifications
Headlamp High/Low Beam	HB3 60W
Front Direction Indicators	WY21W 21W
Reverse Lamps	W16W 16W
Stop Lamps	W21W 21W

### Bulb Replacement

Before replacing any bulb, turn off the START/STOP Switch and lighting switch to avoid any possibility of a short circuit.

**Note:** *Only replace bulbs with the same type and specification.*

If the bulb glass is scratched or contaminated, it may mean the bulb can not concentrate the light. Take care NOT to

Bulb	Specifications
License Plate Lamps	W5W 5W
Rear Direction Indicators	WY16W 16W
Front Interior Lamps	W5W 5W

touch the glass with your fingers; If necessary, clean the glass with methylated spirits to remove fingerprints.

Consult an MG Authorised Repairer on specific replacement operation.

# EMERGENCY INFORMATION

---

## High/Low Beam Bulb Renewal

- 1 Open the bonnet—see “Bonnet” in the “Maintenance” section.
- 2 Disconnect the battery negative terminal.
- 3 Remove 10 screws fixing the front compartment trim cover to the body, and remove the front compartment trim cover.
- 4 Identify and locate the high/low beam bulb cover plug. Rotate the cover anti-clockwise and remove the cover plug.

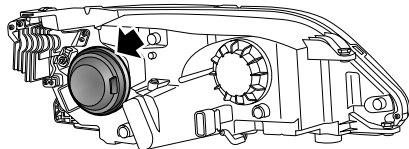

- 5 Rotate the bulb anti-clockwise and remove.
- 6 Remove the wiring connector from the bulb.
- 7 Refit the wiring connector to the new bulb.
- 8 Locate the bulb holder in the lamp, rotate clockwise until fully secured.
- 9 Refit the bulb cover plug, rotate clockwise until fully secure.

## EMERGENCY INFORMATION

---

- 10 Connect the negative battery terminal.
- 11 Test lamp operation.
- 12 Refit the front compartment trim cover to the body.
- 13 Close the bonnet—see “Bonnet” in the “Maintenance” section.

### Front Direction Indicators Bulb Renewal

- 1 Open the bonnet—see “Bonnet” in the “Maintenance” section.
- 2 Disconnect the battery negative terminal.
- 3 Remove 10 screws fixing the front compartment trim cover to the body, and remove the front compartment trim cover.
- 4 Identify and locate the bulb cover plug. Rotate the cover anti-clockwise and remove the cover plug.

## EMERGENCY INFORMATION

---

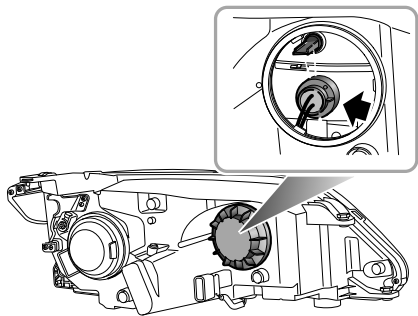

- 5 Remove the bulb holder from the lamp unit. Remove the bulb.
- 6 Fit new bulb. Locate the bulb holder in the lamp assembly, ensure it is fully secured.
- 7 Locate the bulb cover, rotate clockwise until fully secure.
- 8 Connect the negative battery terminal.

- 9 Test lamp operation.
- 10 Refit the front compartment trim cover to the body.
- 11 Close the bonnet—see “Bonnet” in the “Maintenance” section.

### Reverse Lamps Bulb Renewal

- 1 Disconnect the battery negative terminal.
- 2 Open the tailgate.
- 3 Using a suitable pry bar or lever, carefully remove the cover trim.
- 4 Rotate the bulb holder anti-clockwise and remove the bulb from holder.
- 5 Fit the new bulb into the holder.
- 6 Insert bulb holder in lamp assembly, rotate clockwise until fully secure.
- 7 Connect the negative battery terminal.
- 8 Test lamp operation.
- 9 Refit the cover trim.
- 10 Close tailgate.

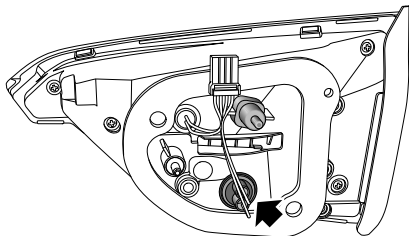

# EMERGENCY INFORMATION

## Stop Lamps Bulb Renewal

- 1 Disconnect the battery negative terminal.
- 2 Open the tailgate.
- 3 Using a suitable pry bar or lever, carefully release and remove the securing screw cover trim.
- 4 Remove the 2 screws securing the lamp to the body.

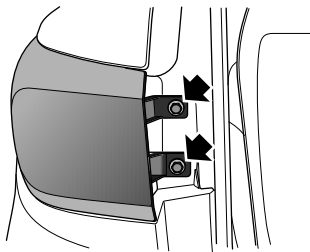

- 5 Release the lamp from the front fixing and withdraw from body, disconnect the wiring connector.
- 6 Rotate the bulb holder in an anti-clockwise direction.

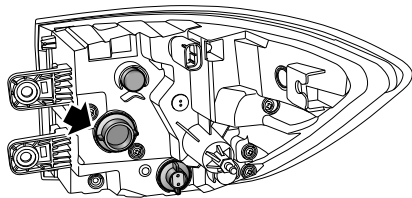

- 7 Remove bulb holder and remove bulb.
- 8 Fit new bulb to bulb holder.
- 9 Insert bulb holder in lamp assembly, rotate clockwise until fully secure.
- 10 Reconnect the wiring connector, position the lamp to the body, ensure the front retaining clip is aligned and fully located. Push the lamp forwards to locate in the clip. Fit screws and tighten to 2.7 - 3.3 Nm .

## EMERGENCY INFORMATION

---

- 11 Refit screw cover trim.
- 12 Reconnect battery negative terminal.
- 13 Test lamp operation.
- 14 Close tailgate.

### License Plate Lamps Bulb Renewal

- 1 Disconnect the battery negative terminal.
- 2 Open the tailgate.
- 3 Using a suitable tool, carefully remove the tailgate lower panel retaining screw covers, and remove 2 screws fixing the tail gate lower trim panel assembly to the tail gate.
- 4 Using a suitable pry bar, release the tailgate securing clips and remove the tailgate trim.
- 5 Carefully lever the lamp out of the aperture.
- 6 Release the bulb from the bulb holder.

## EMERGENCY INFORMATION

---

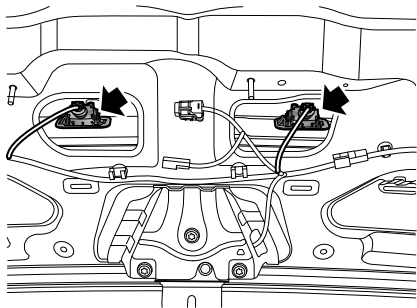

- 7 Insert the new bulb in the lamp bulb holder.
- 8 Position the lamp in the tailgate, and push until fully secured.
- 9 Position the tailgate trim to align the clips, gently tap the trim toward the tailgate to ensure the clips are fully located secure and refit 2 screws fixing the tailgate lower trim panel assembly to the tailgate.
- 10 Refit the lower tailgate trim panel retaining screw covers.
- 11 Reconnect battery negative terminal.
- 12 Test lamp operation.
- 13 Close tailgate.



### Rear Direction Indicators Bulb Renewal

- 1 Disconnect the battery negative terminal.
- 2 Open the tailgate.
- 3 Using a suitable pry bar or lever, carefully release and remove the securing screw cover trim.
- 4 Using a suitable 10 mm spanner/socket wrench, remove the 2 screws securing the lamp to the body.

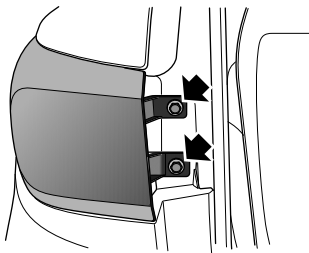

- 5 Release the lamp from the front fixing and withdraw from body, disconnect the wiring connector.
- 6 Rotate the bulb holder in an anti-clockwise direction.

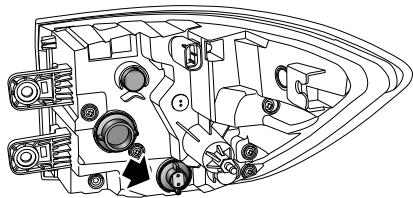

- 7 Remove bulb holder and remove bulb.
- 8 Fit new bulb to bulb holder.
- 9 Insert bulb holder in lamp assembly, rotate clockwise until fully secure.
- 10 Reconnect the wiring connector, position the lamp to the body, ensure the front retaining clip is aligned and fully located. Push the lamp forwards to locate in the clip. Fit screws and tighten to 2.7 - 3.3 Nm .

## EMERGENCY INFORMATION

---

- 11 Refit screw cover trim.
- 12 Reconnect battery negative terminal.
- 13 Test lamp operation.
- 14 Close tailgate.

### Front Interior Lamp Bulb Renewal

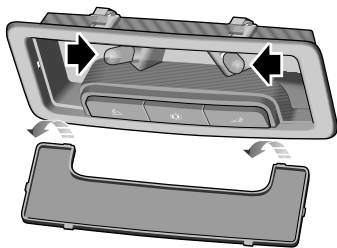

- 1 Disconnect the battery negative terminal.
- 2 Use a small flat-bladed screwdriver to gently prise the lens from the lamp assembly.
- 3 Pull the bulb from its mounting to remove.

Installation of the bulb is a reversal of the removal process. When installing the lens, locate the two prongs at the front of the lens and then carefully flex the lens to locate the two prongs at the rear of the lens into the lamp assembly. Push the lens upwards until it 'clicks' into position.

## **Maintenance**

---

254 *Maintenance*

257 *Bonnet*

259 *Front Compartment*

260 *Cooling System*

263 *Brake*

265 *Battery*

267 *High Voltage Battery Pack*

269 *Washer*

271 *Wipers*

274 *Tyre*

280 *Cleaning and Vehicle Care*

# MAINTENANCE

---

## Maintenance

### Routine Servicing

The safety, reliability and performance of your car will depend partly on how well it is maintained. You must ensure that maintenance is carried out when required and according to the information contained in the "Service Schedule" - see [www.mg.co.uk](http://www.mg.co.uk) - owners section.

### Servicing

For next service information please consult your service records.

Some markets feature a service reminder in the IPK message centre.

### Service History

Ensure MG Authorised Repairer registers the Service History after each service.

### Brake Fluid Replacement

Replace the brake fluid according to the information contained in the "Service Schedule" - see [www.mg.co.uk](http://www.mg.co.uk) - owners section.

**Note:** *Brake fluid replacement will be an additional cost.*

### Coolant Replacement

The coolant (anti-freeze and water solution) needs to be replaced according to the information contained in the "Service Schedule" - see [www.mg.co.uk](http://www.mg.co.uk) - owners section.

**Note:** *Coolant replacement will be an additional cost.*

## Owner Maintenance



***Any significant or sudden drop in fluid levels, or uneven tyre wear, should be reported without delay to MG Authorised Repairer.***

In addition to the routine services referred to previously, a number of simple checks must be carried out more frequently. Advice is given on the pages that follow.

### Daily Check

- Operation of lights, horn, wipers, washers and warning lamps.
- Operation of seat belts and brakes.
- Look for fluid deposits underneath the car that might indicate a leak.
- Check tyre appearance.

### Weekly Check

- Coolant levels.
- Brake fluid level.
- Windscreen washer fluid level.
- Operate air conditioning.

## Special Operating Conditions

If your car is frequently used in dusty conditions, or operated in extreme climates where sub-zero or very high ambient temperatures are normal, more frequent attention may need to be paid to servicing requirements. You need to carry out special maintenance operations (refer to Service Schedule) or contact an MG Authorised Repairer.

## Safety in the Garage



***Cooling fans may commence operating after the vehicle is switched off, and continue operating for a number of minutes. Keep clear of all fans while working in the front motor compartment***

If you need to carry out maintenance, observe the following safety precautions at all times:

- If the car has been driven recently, **DO NOT TOUCH** cooling system components until the drive motor has been fully cooled down.

# MAINTENANCE

---

- DO NOT TOUCH electrical leads or components when the START/STOP Switch is on.
- DO NOT work underneath the car with a wheel changing jack as the only means of support.
- Wear protective clothing and work gloves.
- Remove watches and jewelry before working in the front compartment.
- DO NOT allow tools or metal parts of the car to make contact with the battery leads or terminals.

## **Toxic Liquid**

Fluids used in motor vehicles are poisonous and should not be consumed or brought into contact with open wounds. These include: battery acid, coolant, brake fluid and windscreen washer fluid.

For your own safety, ALWAYS read and obey all instructions printed on labels and containers.

## Bonnet

### Opening the Bonnet



**DO NOT drive when the bonnet is not closed or retained only by the safety catch.**

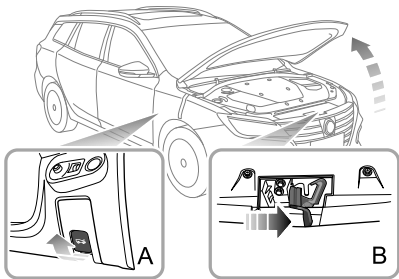

- 1 From the inside of the vehicle, pull the bonnet release handle (Figure A).

- 2 Move the safety catch release handle on the bonnet lock assembly in the direction of the arrow (Figure B) to release the bonnet safety catch.
- 3 Raise the bonnet, hold it up. Ensure the bonnet support rod is securely located.

### Closing the Bonnet

Support the bonnet by one hand, release the support rod using the other hand, and place it firmly into the support rod base. Then hold the bonnet using both hands and lower it, allowing it to drop for the last 20cm ~ 30cm to fully close the bonnet.

By attempting to lift the front edge of the bonnet, check if the lock is fully engaged after closing the bonnet. If it is not fully engaged, you must repeat the operation.

### Bonnet Open Warning

If the bonnet is not fully engaged, when the START/STOP switch is in the ON/READY position, the corresponding alarm icon will be displayed in the information message centre of the instrument pack.

## MAINTENANCE

---

### IMPORTANT

- For safety reasons, the bonnet should be fully latched when driving. Therefore every time the bonnet is opened, you must check after closing that the bonnet is securely latched, e.g. the bonnet edge is flush with the body of the car.
- You should stop the car immediately when safety permits and close the bonnet if it is not closed fully when driving.
- Beware of injury to hands while fully closing the bonnet with a downward force.



## Front Compartment



**While working in the front compartment, always observe the safety precautions listed under 'Safety in the Garage', refer to 'Maintenance' in 'Maintenance' section.**

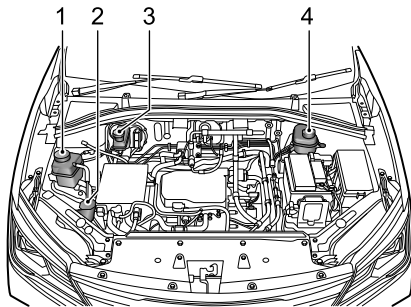

- 1 Electric drive transmission coolant expansion tank ( black cap )
- 2 Washer fluid reservoir (blue cap)
- 3 Brake fluid reservoir (black cap)
- 4 Battery coolant expansion tank ( black cap )

# MAINTENANCE

## Cooling System



**DO NOT** remove the coolant expansion tank cap when the cooling system is hot - escaping steam or hot coolant could cause serious injury.

**Note:** Prevent coolant coming into contact with the vehicle body when topping up. Coolant will damage paint.

If the coolant level falls appreciably during a short period, and you suspect that there may be a leak, please seek an MG Authorised Repairer for service.

## Coolant Check and Top Up-EDS

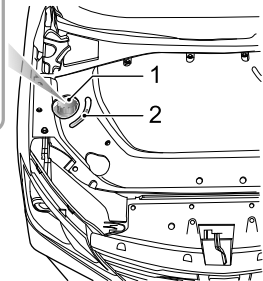
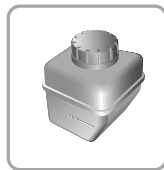

- 1 Coolant Expansion Tank Cap
- 2 Viewport

The cooling system should be checked weekly when the cooling system is cold and with the car resting on level ground. Open the bonnet to check the coolant level from the viewport. If the coolant level is below "MIN" mark,

open the coolant expansion tank cap and top up coolant. The coolant level should not be higher than "MAX" mark.

## Coolant Check and Top Up-ESS

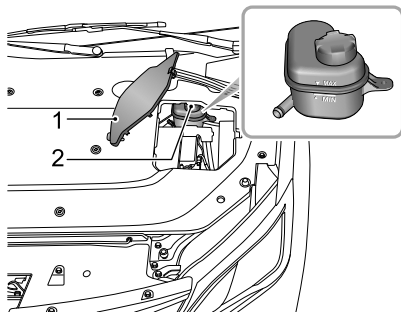

- 1 Battery Cover
- 2 Coolant Expansion Tank Cap

The cooling system should be checked weekly when the cooling system is cold and with the car resting on level

ground. Open the bonnet, lift the battery cover and check the coolant level. If the coolant level is below "MIN" mark, open the coolant expansion tank cap and top up coolant. The coolant level should not be higher than "MAX" mark.

## Coolant Specification



**Coolant is poisonous and can be fatal if swallowed - keep coolant containers sealed and out of the reach of children. If accidental contact of coolant by children is suspected, seek medical assistance immediately.**



**Prevent the coolant coming into contact with the skin or eyes. If this occurs, rinse immediately with plenty of water. If eyes are still red, painful or uncomfortable, seek medical attention immediately.**

Please use the coolant (mix of water and antifreeze) which is recommended and certified. Please refer to 'Recommended Fluids and Capacities' in "Technical Data" chapter.

## MAINTENANCE

---

*Note: The addition of corrosion inhibitors or other additives to the cooling system of this car may severely disrupt the efficiency of the system and cause parts damage. For cooling system issues please consult an MG Authorised Repairer.*

## Brake

### Brake Pads



**DO NOT rest your foot on the brake pedal while driving; this may overheat the brakes, reduce their efficiency and cause excessive wear.**

For the first 900 miles(1500 km) you should avoid situations where heavy braking is required.

Remember that regular servicing is vital to ensure that all the brake components are examined for wear at the correct intervals, and replaced when required to ensure long term safety and optimum performance during the intervals outlined in the Service Schedule.

The vehicle needs to run in for 500 miles(800 km) after brake pad or disc replacement.

### Brake Fluid Check and Top Up



**Brake fluid is highly toxic, keep containers sealed and out of the reach of children. If accidental contact of brake fluid is suspected, seek medical attention immediately.**



**Prevent brake fluid coming into contact with the skin or eyes. If this occurs, rinse immediately with plenty of water. If eyes are still red, painful or uncomfortable, seek medical attention immediately.**

The brake fluid level should be checked weekly when the system is cold and with the car on level ground.

The brake fluid level can be seen through the reservoir and should be maintained between the "MAX" and "MIN" marks.

**Note: Do not allow the brake fluid level to drop below the "MIN" mark or rise above the "MAX" mark.**

# MAINTENANCE

---



**Note:** Brake fluid will damage painted surfaces. If you accidentally spill the brake fluid on the painted surface, soak up any spillage with an absorbent cloth immediately and wash the area with water or car shampoo.

## Brake Fluid Specification

Use the brake fluid recommended and approved by the manufacturer. Refer to "Recommended Fluids and Capacities" in the "Technical Data" section.

IMPORTANT
Replace brake fluid regularly according to the Service Schedule.

## Battery

### Battery Maintenance



**DO NOT** leave electric components switched on when the vehicle is not in **READY** mode, otherwise the battery may become flat, resulting in the failure to start the vehicle and the reduction of battery life.



Always store batteries upright, tilting may allow the corrosive substances contained within the battery to leak out.



Never attempt to dismantle a battery, they are sealed units.

The battery will be visible after the bonnet or the front compartment trim panel is opened. The battery is maintenance-free, therefore there is no need to refill fluid.

**Note:** It is recommended to set the power mode to **READY** for half an hour every week to help extend the service life of the battery. If the vehicle is stored for a long time, remove the negative terminal from the

battery. Make sure that the vehicle power system has been turned off before connecting or disconnecting the negative terminal.

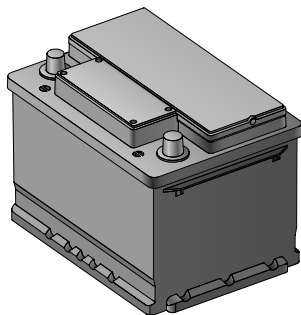

### Battery Replacement



The battery contains sulphuric acid, which is corrosive.

## MAINTENANCE

---

The battery contains sulphuric acid, which is corrosive. Please go to an MG Authorised Repairer to remove and refit the battery. Only fit a replacement battery of the same type and specification as the original to maintain the correct vehicle functionality.



The used battery should not be discarded at will, for it is harmful to the environment. It must be recycled by professional institutes. Please consult an MG Authorised Repairer for more details.



## High Voltage Battery Pack

### Precautions and restricted conditions for use of battery



*If the vehicle is not going to be used, parked, or stored for a long time it is necessary to charge the vehicle at least once every 3 months. During this time, the High Voltage battery state of charge should not be allowed to drop below 50%.*



*If the battery is in a low state of charge and the instrument pack displays no valid driving range, the vehicle **MUST NOT** be left in a stored state for more than 7 days without being charged to above 50%.*



*Failure to follow these guidelines will result in HV battery damage and invalidate the warranty.*



**DO NOT attempt to dismantle the battery pack or any High Voltage components - THESE ARE DANGEROUS. Any signs of dismantling or damage caused by attempts to dismantle will invalidate the warranty.**

- 1 DO NOT park the vehicle in conditions where the ambient temperature exceeds 45°C for more than 15 days. This will effect the performance and service life of the high voltage battery.
- 2 To maintain or improve the service life of the high voltage battery, it is recommended that you use a slow charging method wherever possible, rapid charging should only be used for long distance journeys or emergencies.
- 3 It is recommended using the vehicle at least once a month.

Where possible it is recommended that you carry out a slow charging (equalisation charging) every month to extend the service life of high-voltage battery pack. The battery management system will monitor the status of the high voltage battery pack. After

## MAINTENANCE

---

monitoring for a period of time, if an equalising charge has not been carried out for some time the message centre in the instrument pack will display 'Please Charge for BMS Balance'. At this time you must carry out an equalising charge. For operation mode, please refer to 'Equalisation Charging' in 'Starting & Driving' section.

- 4 In the event of an accident, damage to the high voltage battery or any of its related components, or any repairs made to the high voltage system the car must be inspected by qualified personnel at an MG Authorised Repairer.
- 5 In the event of any accident or body repairs being required please consult the qualified personnel at an MG Authorised Repairer. The repair may require high voltage battery isolation or specialist HV component removal.

### IMPORTANT

Only fully trained and qualified personnel are allowed to work on the high voltage systems and components of this vehicle. Any disassembly of such systems or components is strictly prohibited.

## Washer

### Windscreen Washer Fluid Check and Top Up



*When filling the washer fluid, DO NOT let the washer fluid spill on the paint surface of vehicle body. In case the washer fluid is spilled on hands or other parts of the body, please immediately wash with clean water.*

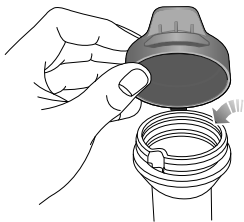

Check the washer fluid level every week. When the level of washer fluid is low, please top up the washer fluid as instructed.

**Note:** DO NOT use an anti-freeze or vinegar/water solution in the washer reservoir - anti-freeze will damage paintwork while vinegar will damage the washer pump.

#### IMPORTANT

- Use the washer fluid recommended and certified by the manufacturer. Misuse of washer fluid in winter may cause damage to the washer motor due to freezing.
- Using the washer switch when there is no washer fluid may cause damage to the washer motor.
- Operating the wipers when the windscreen is dry and there is no washer fluid may cause damage to the windscreen and wipers. Please spray the washer fluid and start the wipers when there is adequate washer fluid.

# MAINTENANCE

---

## Washer Nozzles

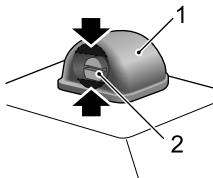

Operate the washers periodically to check that the nozzles are clear and properly directed.

The windscreen washer nozzles are configured during the production, so generally there is no need for adjustments. To adjust the windscreen washer nozzle, you can insert a small flat-bladed screwdriver in the upper and bottom gaps (as indicated by the arrow) between the housing (1) and the nozzle (2) and turn downward or upward slightly to adjust to appropriate injection angle.

If the nozzle is obstructed, insert a needle or thin metal wire into the hole to remove the obstruction.

## Washer Fluid Specification

Use the washer fluid recommended and certified by the manufacturer. Refer to "Recommended Fluids and Capacities" in the "Technical Data" section.

## Wipers

### Wiper Blades

#### IMPORTANT

- Grease, silicon and petroleum products impair the blade's wiping capability. Clean the wiper blades in warm soap water, and check their status periodically.
- Clean the windscreen frequently. **DO NOT** use wipers to remove stubborn or ingrained dirt, it will reduce their effect and their life span.
- If signs of hardness or cracking in the rubber are found, or if the wipers leave streaks or unwiped areas on the screen, then the wiper blades should be replaced.
- Clean the windscreen regularly with an approved glass cleaner and ensure the windscreen is thoroughly cleaned before fitting replacement wiper blades.
- Only fit replacement wiper blades that are identical to the original specification.
- Clean ice and snow from the wipers and ensure they are not frozen or otherwise sticking to the windscreen before attempting to operate them.

# MAINTENANCE

---

## Replacing Front Windscreen Wiper Blades

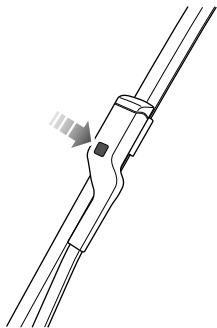

- 1 With the bonnet in closed state, and within 20 seconds of setting the START/STOP Switch to the OFF position, operate the wiper stalk switch by pressing down and releasing, the wipers will enter the 'service position' and stop on the windscreen.
- 2 Lift the wiper arm away from the windscreen.
- 3 Press the button on the wiper arm (as illustrated), and pull the upper end of the wiper blade outward to disengage from the wiper arm.
- 4 Unhook the blade from the wiper arm and discard.
- 5 Locate the new wiper into the slot of the wiper arm.
- 6 Push the wiper blade towards the arm until the wiper blade is engaged.
- 7 Check whether the wiper blade is fitted correctly to the arm before positioning on the windscreen.
- 8 Operate the wiper stalk switch by pressing down again and releasing, or set the START/STOP Switch to ON, the wipers will exit the service mode and automatically return to its original position

### Replacing Rear Wiper Blades

4 Place the wiper assembly back on the rear window.

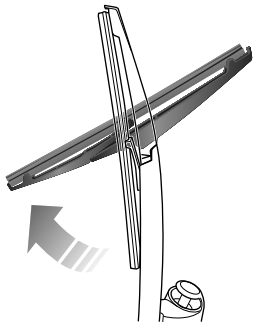

- 1 Lift the wiper arm away from the rear window.
- 2 Rotate the wiper blade as shown in the figure, to remove it from the wiper arm and discard.
- 3 Position the fitting of the new wiper blade into the slot of the wiper arm. Ensure the wipers blade is properly secured on the wiper arm.

# MAINTENANCE

---

## Tyre

### Overview

- Take extra care when using new tyres for the first 300 miles (500km).
- Avoid excessive cornering at speed.
- Regularly check tyres for signs of damage. **DO NOT** remove foreign objects such as screws or nails from the tyre. If a tyre shows any signs of damage please ensure it is inspected by a reputable tyre fitter for advice.
- Prevent tyres coming into contact with any chemicals such as oil, grease or fuel.
- Ensure valve caps are always fitted.
- If the tyre is to be removed always mark the tyre/wheel orientation to ensure correct reinstallation.
- If removed tyres are to be stored, please ensure they are kept in dark, dry and cool conditions.

### New Tyres

New tyres may not have the same adhesion properties of the old tyres, please run in at moderate speed using a

careful driving style for the first 300 miles (500km). This action could benefit tyre life.

The damage of a tyre or rim may happen unnoticed. If abnormal vibration or handling is experienced, that means the tyre or rim may have been damaged. Please slow down and park your vehicle in a suitable, safe location, then check the tyre and rim. If you can't see the damage from the outside continue to drive the vehicle slowly to a reputable tyre fitter or MG Authorised Repairer for inspection and advice.

### Directional Tyres

Directional tyres are marked with 'direction of rotation' (DOR). To maintain handling characteristics, tyre performance, low road noise and extend tyre life, tyres must always be fitted with indication arrow showing the correct 'DOR'.

### Tyre Life

Correct tyre pressures and moderate driving style can extend tyre life. Recommendations:



- If the vehicle is to be stored for a lengthy time, please move your vehicle at least once every two weeks to 'rotate the tyres'.
- Tyre pressures should be checked monthly when the tyres are cold.
- Avoid cornering at excessive speeds.
- Regularly check tyres for abnormal wear patterns.

The following factors affect the tyre life:

### ***Tyre Pressures***

Incorrect tyre pressures can result in poor driving characteristics and a shortened tyre life due to abnormal wear.

### ***Driving Style***

Excessively harsh acceleration and braking (tyres emit a harsh noise) whilst cornering will reduce tyre life.

### ***Wheel Balance***

Every new vehicle leaves the factory having had the wheels dynamically balanced. Out of balance wheels may be due to many factors.

If wheels are out of balance, shaking or vibration of the steering mechanism may occur and the tyres may start to wear excessively. It is important to restore wheel balance as quick as possible. Each wheel should be rebalanced after installing a new tyre or having a tyre repair.

### ***Wheel Alignment***

Incorrect wheel alignment can cause excessive tyre wear and affect vehicle safety. If the tyres show signs of abnormal wear, check the wheel alignment and seek advice from an MG Authorised Repairer.

# MAINTENANCE

---

## Caring for Your Tyres



**DEFECTIVE TYRES ARE DANGEROUS!**  
**DO NOT drive if any tyre is damaged, is excessively worn, or is inflated to an incorrect pressure.**

Always drive with consideration for the condition of the tyres, and regularly inspect the tread and side walls for any sign of distortion (bulges), cuts or wear.

**Note: Avoid tyre contact with oils, grease and fuel.**

## Tyre Pressures



**Before a long distance journey, the tyre pressures should be checked.**

Check the pressures at least every month, when the tyres are cold.

If it is necessary to check the tyres when they are warm, you should expect the pressures to have increased by 0.3 ~ 0.4bar (4.35 ~ 5.8psi). In this circumstance, NEVER let air out of the tyres in order to match the recommended pressures (cold).

## Valves

Keep the valve caps firmly secured - they prevent dirt from entering the valve. Check the valve for leaks (listen for a tell-tale hissing) when you check the tyre pressure.

## Punctured Tyres

Your vehicle is fitted with tyres which may not leak if penetrated by a sharp object, provided the object remains in the tyre. If you are aware of this occurring, reduce speed immediately and drive with caution until the spare wheel can be fitted, or repairs undertaken.

**Note: If the sidewall of the tyre is damaged or distorted, replace the tyre immediately, do not attempt a repair.**

## Tyre Wear Indicators

The original tyre treads have a 1.6 millimeter high wear mark indicator that is perpendicular to the wheel rolling direction. These indicators are moulded into the tread pattern at several points around the circumference. A mark on the side of a tyre, such as upper case lettering TWI or a triangle indicate the position of the wear mark.

When the tread has worn down to 1.6mm or below, the indicators will come to the surface of the tread pattern, producing the effect of a continuous band of rubber across the width of the tyre.

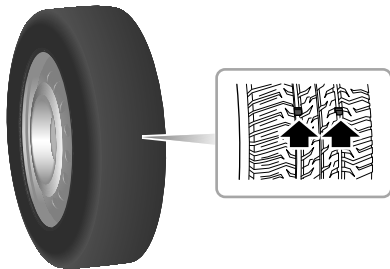

## IMPORTANT

A tyre **MUST** be replaced as soon as a wear indicator becomes visible.

## Replacement of Tyres



*When replacing tyres it is strongly recommended that the new tyres are of the same specification as the original tyres. Alternative tyres, of a different specification, or unqualified tyres may adversely affect the car's driving characteristics and safety. In order to maintain comfort and safety it is recommended to seek advice from an MG Authorised Repairer.*

Always have replacement wheels and tyres balanced before use.

## Wheel Fitment Rotation

It is not recommended that you swap wheels from side to side or front to rear in order to equalise tyre wear. Your vehicle is fitted with Tyre Pressure Monitoring System which means that each wheel is programmed to the relative position.

# MAINTENANCE

---

If you do wish to swap wheels and tyres around on the vehicle please consult an MG Authorised Repairer as extra coding will be required.

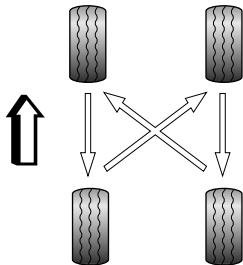

## Tyre/Snow Chains

Unsuitable tyre/snow chains may damage the tyres, wheels, suspension, brakes or bodywork of your car.

Please pay attention to the following requirements in the usage:

- The tyre/snow chains can only be fitted on the front wheels;
- The thickness of tyre/snow chains must not exceed 12mm;
- Please always observe the installation and tension instructions for the tyre/snow chains, as well as the speed limitations of different roads;
- Do not drive faster than 30mph (50km/h);
- To avoid the tyre damage and excessive wear of the tyre/snow chains, the tyre/snow chains must be removed while driving on the road without snow.

**For this vehicle, the only specification of wheels and tyres that will support tyre/snow chains are as follows:**

Wheel rim size: 6.5J×16

Tyre size: 205/60 R16

**Note:** *If you drive on snow covered and icy roads, it is recommended to use winter tyres. Consult an MG Authorised Repairer for details.*

# MAINTENANCE

---

## Cleaning and Vehicle Care



*Observe all safety precautions on cleaning products; Do Not drink fluids and keep them away from the eyes.*

## Exterior

### Washing Your Car



*Some high pressure cleaning systems will penetrate door, window and sunroof seals, and damage lock mechanisms. DO NOT aim water jets directly at components that might be easily damaged. Ensure the vehicle power system is OFF when washing your car.*



*Do not clean the front compartment with high pressure water since it may damage the electrical system of the vehicle.*

In order to preserve the paint finish on your car, please observe the following care points:

- DO NOT use hot water to wash the car.
- DO NOT use detergents or washing up liquid.

- In hot weather, DO NOT wash the car in direct sunlight.
- When using a hose, DO NOT aim the water directly at window, door or sunroof seals, or through wheel apertures onto the brake components.

If the car is particularly dirty, use a hose to flush grime and grit from the bodywork, prior to washing. Then, wash the car using cold or lukewarm water containing a good quality wash and wax shampoo. Always use plenty of water to ensure that grit is flushed from the surface and not ground into the paintwork. After washing, rinse the bodywork with clean water and dry off with a chamois leather.

### *Cleaning the underside*

**Note: DO NOT use a high pressure hose to clean the front compartment – damage to the car's electronic systems may occur.**

From time to time, but particularly during winter months when salt has been used on the roads, use a hose to wash the underside of the car. Flush away accumulations of mud and thoroughly clean those areas where debris can easily collect (wheel arches and panel seams, for example).

## IMPORTANT

- Avoid cleaning the vehicle in direct sunlight.
- When cleaning the vehicle in winter avoid spraying water directly onto door locks and panel gaps due to risk of icing.
- Do not use rough sponges or cloth to clean the car, this will damage the paintwork finish.
- When cleaning the headlamps do not use a dry cloth or sponge, use only warm soapy water.

### *Cleaning with a High Pressure Cleaner*

**Note:** Always read the manufacturers operating instructions.

When using high pressure washers, always ensure there is adequate distance between the spray nozzle and any soft materials, decals or rubber seals.

**Note:** **DO NOT** direct the pressure washer nozzle directly toward the high voltage charging point or high voltage battery connections on the underside of the vehicle.

## IMPORTANT

- Please pay attention to the operating instructions of high pressure cleaner.
- High pressure cleaners should not be closely directed at soft parts of the vehicle.

### **Removing tar spots**

Use white spirit to remove tar spots and stubborn grease stains from the paintwork. Then wash the area immediately with soapy water to remove all traces of the spirit.

### **Body Protection**

After washing, examine the paintwork for damage. If the damage has revealed bare metal, use a colored primer first, then apply the correct colour base coat and finish off with a lacquer pencil, if appropriate. Carry out this treatment after washing but before polishing or waxing. More extensive damage to paint or bodywork must be repaired in accordance with the manufacturer's recommendations. Failure to do this will invalidate the Anti-Corrosion Warranty. If in doubt, ask your MG Authorised Repairer.

# MAINTENANCE

---

## Polishing the Paintwork



**DO NOT use car polish containing coarse abrasives – these will remove the paint film and damage the gloss finish.**

Occasionally treat the paint surface with an approved polish containing the following properties:

- Very mild abrasives to remove surface contamination without removing or damaging the paint.
- Filling compounds that will fill scratches and reduce their visibility.
- Wax to provide a protective coating between the paint and the elements.

**Note: If possible, avoid applying polish or wax products to window glass and rubber seals.**

## Wiper Blades

Wash in warm soapy water. DO NOT use spirit or solvent based cleaners.

## Windows and Mirrors

Regularly clean all windows, inside and out, using an approved glass cleaner.

**Windscreen:** In particular, clean the outside of the screen with glass cleaner after washing the car with wash and wax products, and before fitting new wiper blades.

**Rear screen:** Clean the inside with a soft cloth, using a side to side motion to avoid damaging the heating elements.

**Note: DO NOT scrape or use abrasive cleaners on the inside of the rear screen – this will damage the heating elements.**

**Mirrors:** Wash with soapy water. Use a plastic scraper to remove ice. DO NOT use abrasive cleaning compounds or metal scraper.

## Plastic Components

Any plastic components should be cleaned using conventional cleaning methods and not be treated with abrasive materials.



## Paint Damage

Any paint damage or stonechips should be treated with suitable paint/lacquer materials immediately to avoid invalidating the Anti Corrosion Warranty.

## Weather Strips and Rubber Seals

Any weather strips or rubber aperture seals should be treated with suitable materials (silica gel) if they are cleaned using strong detergents, this should avoid any sticking and maintain the service life of the seal.

## Wheels



***When cleaning the wheels any materials or water that contact the brake disc directly may effect braking efficiency.***

In order to ensure the wheels are kept in optimum condition they should be cleaned regularly.

Only use a recommended non-acidic propriety wheel cleaner. Always read the instructions on the product.

## Cleaning the Interior

### Plastic materials

Clean plastic-faced materials with diluted upholstery cleaner, then wipe with a damp cloth.

***Note: DO NOT polish dashboard components – these should remain non-reflective.***

### Carpet and fabrics

Clean with diluted upholstery cleaner - test a concealed area first.

### Leather

Clean leather trim with warm water and a non-detergent soap. Dry and polish the leather with a dry, clean, lint-free cloth.

***Note: DO NOT use petrol, detergents, furniture creams or polishes as cleaning agents.***

# MAINTENANCE

---

## Instrument Pack, Audio and Navigation Display

Clean with a dry cloth only. DO NOT use cleaning fluids or sprays.

## Airbag Module Covers



**DO NOT allow these areas to be flooded with liquid and DO NOT use petrol, detergent, furniture cream or polishes.**

To protect damage to the airbag SRS, the following areas should be cleaned sparingly with a damp cloth and upholstery cleaner ONLY:

- Steering wheel centre pad.
- Area of dashboard containing the passenger airbag.
- Area of roof lining and front pillar finishers which enclose the side head impact protection modules.

## Seat Belts



**DO NOT use bleaches, dyes or cleaning solvents on seat belts.**

Extend the belts, then use warm water and a non-detergent soap to clean. Allow the belts to dry naturally; DO NOT retract them or use the car until they are completely dry.

## **Technical Data**

---

286 *Technical Data Dimensions*

288 *Weights*

289 *Parameters of Traction Motor*

290 *Recommended Fluids and  
Capacities*

291 *Wheel Alignment (Unladen)*

291 *Wheels and Tyres*

291 *Tyre Pressure (Cold)*

# TECHNICAL DATA

## Technical Data Dimensions

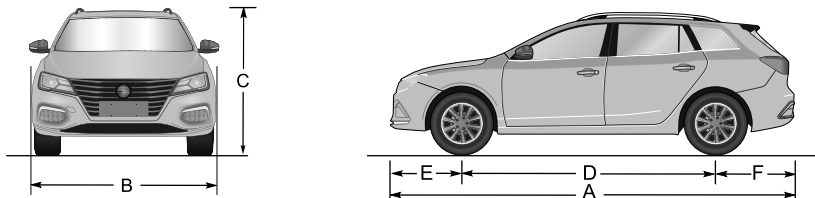

Item, Units	Parameter	
	Battery Pack Type 1	Battery Pack Type 2
Overall length A, mm	4544	
Overall width B, mm	1818	
Overall height C (unladen), mm	1513(body height) 1536(with roof decoration rack)	1521(body height) 1543(with roof decoration rack)
Wheelbase D , mm	2665	

## TECHNICAL DATA

Item, Units	Parameter	
	Battery Pack Type 1	Battery Pack Type 2
Front overhang E, mm	934	
Rear overhang F, mm	945	
Front wheel track, mm	1558	
Rear wheel track, mm	1553	
Minimum ground clearance (laden), mm	116.1	115.2

**Note:** Vehicle length not including the license plate.

**Note:** Rearview mirrors and the deformed portion of tyre wall directly above the touchdown point are not included in the total width.

# TECHNICAL DATA

---

## Weights

Item, Units	Parameters			
	Battery Pack Type 1		Battery Pack Type 2	
	Exclusive	Excite	Exclusive	Excite
Person in cab, person	5			
Unladen vehicle weight (kerb), kg	1550	1532	1550	1565
Gross vehicle weight, kg	1992	1974	1992	2007
Unladen front axle weight, kg	887	877	887	887
Unladen rear axle weight, kg	663	655	663	678
Gross front axle weight, kg	991	981	991	991
Gross rear axle weight, kg	1001	993	1001	1016

## Parameters of Traction Motor

Item, Units	Parameter Values	
	Battery Pack Type 1	Battery Pack Type 2
Traction motor type	Three-phase permanent magnet synchronous motor	
Continuous Power/Maximum Net Power, kW	73/115	
Rated Torque/Peak Torque, Nm	87.1/260	87.1/280
Rated Speed/Maximum Speed, rpm	8000/15000	
Winding Type	△ winding	
Waterproof Grade	IP67	

# TECHNICAL DATA

---

## Recommended Fluids and Capacities

Name	Grade	Capacity	
		Battery Pack Type 1	Battery Pack Type 2
High-voltage battery pack coolant, L	Glycol (OAT)	4.4	4.8
Electric drive transmission coolant, L	Glycol (OAT)	4.2	4
Electric drive transmission oil, L	Shell E-Fluids E6 iX (SL2808)	0.9	
Brake fluid, L	DOT 4	0.8	
Screenwasher detergent, L	ZY-VIII	2.5	
Air conditioning refrigerant, g	R1234yf	600±20	



## Wheel Alignment (Unladen)

Item		Parameter	
		Battery Pack Type 1	Battery Pack Type 2
Front	Camber	-0°7'±45'	-0°15'±45ϕ
	Castor	5°12'±45'	5°05'±45ϕ
	Toe in (Total)	0°12'±15'	0°6'±15ϕ
	Kingpin Inclination	13°06'±45'	12°56'±45ϕ
Rear	Camber	-1°13'±45'	-1°13'±45ϕ
	Toe in (Total)	0°6'±20'	0°6'±20ϕ

## Tyre Pressure (Cold)

Wheel	Unladen
Front Wheels	220kPa/2.2bar/32psi
Rear Wheels	220kPa/2.2bar/32psi

## Wheels and Tyres

Wheel size	6.5J×16
Tyre size	205/60 R16 96V